



STANDARD HORIZON

HX760S

Floating Marine Transceiver with Bluetooth®

Owner's Manual



TABLE OF CONTENTS

RF EXPOSURE SAFETY STATEMENT	4
FCC AND CANADA RADIO LICENSE INFORMATION	5
FCC NOTICE	6
1. GENERAL INFORMATION	7
1.1 INTRODUCTION	7
2. ACCESSORIES	8
2.1 PACKING LIST	8
2.2 OPTIONS	8
3. ABOUT THIS RADIO	9
3.1 ABOUT THE VHF MARINE BAND	9
4. GETTING STARTED	10
4.1 RADIO CARE	10
4.2 BATTERIES AND CHARGERS	10
5. CONTROLS AND INDICATORS	14
5.1 CONTROLS AND SWITCHES	14
5.2 INDICATORS	18
6. BASIC OPERATION	20
6.1 PROHIBITED COMMUNICATIONS	20
6.2 INITIAL SETUP	20
6.3 RECEPTION	20
6.4 TRANSMISSION	21
6.5 USA, CANADIAN, AND INTERNATIONAL CHANNELS	22
6.6 SIMPLEX/DUPLEX CHANEL USE	22
6.7 KEYPAD LOCKING	22
6.8 NOAA WEATHER CHANNELS	23
6.9 PRESET CHANNELS (0 ~ 9): INSTANT ACCESS	24
6.10 MEMORY SCAN	25
6.11 PRIORITY SCAN	26
6.12 DUAL WATCH	27
6.13 TRIPLE WATCH	27
6.14 EMERGENCY (CHANNEL 16 USE)	28
6.15 CALLING ANOTHER VESSEL (CHANNEL 16 OR 9)	29
6.16 OPERATING ON CHANNEL 13	30
6.17 OPERATING ON CHANNEL 67	30
6.18 MEASURING WATER TEMPERATURE	30
6.19 ENABLING S.O.S STROBE OPERATION	31
7. BH-2 Bluetooth® HEAD SET OPERATION	32
7.1 PAIRING	32
7.2 CONTROLS AND SWITCHES	33
7.3 OPERATION	34
8. MENU (“SET”) MODE	36
9. MAINTENANCE	40
9.1 GENERAL	40
9.2 REPLACEMENT PARTS	40
9.3 TROUBLESHOOTING CHART	41
10. VHF MARINE CHANNEL ASSIGNMENT	42
11. WARRANTY	48
12. INSTALLATION OF OPTIONS	51
12.1 FBA-38 ALAKLINE BATTERY CASE	51
13. SPECIFICATIONS	52
13.1 GENERAL	52
13.2 TRANSMITTER	52
13.3 RECEIVER	53
13.4 Bluetooth®	53

Congratulations on your purchase of the **HX760S**! Whether this is your first portable marine VHF transceiver, or if you have other STANDARD HORIZON equipment, the STANDARD HORIZON organization is committed to ensuring your enjoyment of this high performance transceiver, which should provide you with many years of satisfying communications even in the harshest of environments. STANDARD HORIZON technical support personnel stands behind every product sold, and we invite you to contact us should you require technical advice or assistance.

We appreciate your purchase of the **HX760S**, and encourage you to read this manual thoroughly, so as to learn and fully understand the capabilities of the **HX760S**.

NOTE

Water resistance of the transceiver is assured only when the battery pack is attached to the transceiver and **MIC/SP** cap is installed in the **MIC/SP** jack.

WARNING

This radio is capable of transmitting on Marine VHF.

The FCC allows the use of VHF Marine band on water areas only. However the FCC does not allow the use of the VHF Marine band when on land. If persons use the VHF Marine Band on land and interfere with others communicating, the FCC will be notified and search for the interference. Responsible parties found to be transmitting on the VHF Marine Band on land could be fined up to \$10,000 for the first offense.

RF EXPOSURE SAFETY STATEMENT

SAFETY INFORMATION

Your wireless handheld portable transceiver contains a low power transmitter. When the Push-to-Talk (PTT) button is pushed, the transceiver sends out radio frequency (RF) signals. In August 1996, the Federal Communications Commission adopted RF exposure guidelines with safety levels for hand-held wireless devices.

This device is authorized to operate at a duty factor not to exceed 50% (this corresponds to 50% transmission time and 50% reception time).

WARNING: To maintain compliance with the FCC's RF exposure guidelines, this transmitter and its antenna must maintain a separation distance of at least 1 inch (2.5 centimeters) from your face. Speak in a normal voice, with the antenna pointed up and away from the face at the required separation distance.

If you use a headset accessory for this radio, with the radio worn on your body, use only the Vertex Standard belt clip for this transceiver, and ensure that the antenna is at least 1 inch (2.5 centimeters) from your body when transmitting.

Use only the supplied antenna. Unauthorized antennas, modifications, or attachments could damage the transmitter, and may violate FCC regulations.

FCC AND CANADA RADIO LICENSE INFORMATION

Standard Horizon radios comply with the Federal Communication Commission (FCC) and Industry-Canada requirements that regulate the Maritime Radio Service.

MARITIME STATION LICENSE

An FCC ship station license is no longer required for any vessel traveling in U.S. waters which uses a VHF marine radio, RADAR or EPIRB, and which is not required to carry radio equipment. However, any vessel required to carry a marine radio on an international voyage, carrying a HF single side band radio-telephone or marine satellite terminal. FCC license forms, including applications for ship (605) and land station licenses can be downloaded via the Internet at www.fcc.gov/Forms/Form605/605.html. To obtain a form from the FCC, call (888) 225-5322.

MARINE RADIO CALL SIGN

Currently the FCC does not require recreational boaters to have a Ship Radio Station License. The USCG recommends the boats registration number and the state to be used.

CANADIAN SHIP STATION LICENSING

You may need a license when traveling in Canada. If you do need a license contact their nearest field office or regional office or write:

**Industry Canada
Radio Regulatory Branch
Attn: DOSP
300 Slater Street
Ottawa, Ontario
Canada, KIA 0C8**

FCC / INDUSTRY CANADA INFORMATION

The following data pertaining to the transceiver is necessary to fill out the license application.

VHF Transceiver

FCC Type Accepted: Part 80
Output Power with FNB-V99LI: 1.0/2.5/5.0/6.0 W (Low/Mid/High/Nor)
Emission: 16K0G3E
Frequency Range: 156.025 to 163.275 MHz
FCC Type Number: K6630323X30
Industry Canada Type Approval: 511B-30323X30

Bluetooth® Unit (Built-in)

FCC Type Accepted: Part 15C
Output Power: 0.00056 W
Emission: 16K0G3E
Frequency Range: 2402 to 2480 MHz
FCC Type Number: K660F434X10
Industry Canada Type Approval: 511B-0F434X10

FCC NOTICE

Unauthorized changes or modifications to this equipment may void compliance with FCC Rules. Any change or modification must be approved in writing by STANDARD HORIZON, a Marine Division of VERTEX STANDARD.

NOTICE

This equipment has been tested and found to comply with the limits for a Class B digital device, pursuant to Part 15 of the FCC Rules. These limits are designed to provide reasonable protection against harmful interference in a residential installation. This equipment generates uses and can radiate radio frequency energy and, if not installed and used in accordance with the instructions, may cause harmful interference to radio communications. However, there is no guarantee that interference will not occur in a particular installation. If this equipment does cause harmful interference to radio or television reception, which can be determined by turning the equipment off and on, the user is encouraged to try to correct the interference by one or more of the following measures:

- Increase the separation between the equipment and receiver.
- Connect the equipment into an outlet on a circuit different from that to which the receiver is connected.
- Consult the dealer or an experienced marine electronics technician for help.

1. GENERAL INFORMATION

1.1 INTRODUCTION

The **HX760S** is a Submersible Floating 6-Watt portable two way marine transceiver. The transceiver has all allocated USA, International, or Canadian channels. It has emergency channel 16 which can be immediately selected from any channel by pressing the [**16/9**] key. NOAA (National Oceanic and Atmospheric Administration) Weather channels can also be accessed immediately by pressing the [**WX**] key.

The **HX760S** includes the following features: Memory Scanning, Priority Scanning, NOAA Weather Alert, Battery Saver, easy-to-read large LCD display, EEPROM memory back-up, Battery Life displayed on LCD, and a transmit Time-Out Timer (TOT).

The **HX760S** transmitter provides a full 6 Watt of transmit power and also is selectable to 5, 2.5, and 1 Watt to assist the user in ensuring maximum battery life.

In addition, the **HX760S** can communicate your voice and receiving signal between the **BH-2 Bluetooth®** Head Set and the transceiver.

The **Bluetooth®** word mark and logos are registered trademarks owned by Bluetooth SIG, Inc. and any use of such marks by Vertex Standard Co., Ltd. is under license.

2. ACCESSORIES

2.1 PACKING LIST

When the package containing the transceiver is first opened, please check it for the following contents:

- **HX760S** Transceiver
- **CAT460** Antenna
- **FNB-V99LI** 7.4 V, 1150 mAh Li-Ion Battery Pack
- **CD-39** Charger Cradle for **HX760S**
- **NC-88B** 120VAC Wall Charger for **CD-39**
- **BH-2 Bluetooth®** Head Set
- **CD-40** Charger Cradle for the **BH-2**
- **NC-85B** 120VAC AC Adapter for **CD-40**
- **E-DC-19A** DC Cable with 12 V Cigarette Lighter Plug for **CD-39**
- **CLIP-19** Belt Clip
- Owner's Manual

2.2 OPTIONS

- ① **MH-73A4B** Speaker/Microphone
- ② **MH-57A4B** Mini Speaker/Microphone
- ③ **VC-24** VOX Headset
- ④ **VC-27** Earpiece/Microphone
- ⑤ **CN-3** Radio-to-Ship's-Antenna Adapter
- ⑥ **CD-39** Charger Cradle
- ⑦ **FNB-V99LI** 7.4 V, 1150 mAh Li-Ion Battery Pack
- ⑧ **FBA-38** Alkaline Battery Case
- ⑨ **BH-2 Bluetooth®** Head Set
- ⑩ **CD-40** Charger Cradle for the **BH-2**
- ⑪ **NC-85B/C/U*** AC adapter for the **CD-40**
- ⑫ **E-DC-19A** DC Cable with 12 V Cigarette Lighter Plug
- ⑬ **NC-88B/C/U*** AC Wall Charger for the **FNB-V99LI**
- ⑭ **E-DC-6** DC Cable; plug and wire only

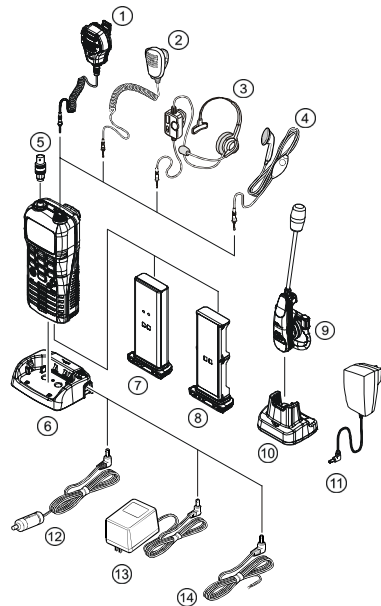

*: "B" suffix is for use with 120 VAC (Type-A plug), "C" suffix is for use with 230 VAC (Type-C plug), and "U" suffix is for use with 230 VAC (Type-BF plug).

Note: Before operating the **HX760S** for the first time, it is recommended that the battery be charged. Please see section "4.1.3 BATTERY CHARGING" for details.

3. ABOUT THIS RADIO

3.1 ABOUT THE VHF MARINE BAND

WARNING

The radio frequencies used in the VHF marine band lie between 156 and 158 MHz with NOAA Weather stations available between 161 and 163 MHz. The marine VHF band provides communications over distances that are essentially “Line of sight” Actual transmission range depends much more on antenna type, gain and height than on the power output of the transmitter. On a fixed mount 25 W radio transmission expected distances can be greater than 15 miles, for a portable 6 W radio transmission the expected distance can be greater than 5 miles in “Line of sight”.

The user of a Marine VHF radio is subject to severe fines if the radio is used on land. The reasoning for this is you may be near an inland waterway, or propagation anomalies may cause your transmission to be heard in a waterway. If this occurs, depending upon the marine VHF channel on which you are transmitting, you could interfere with a search and rescue case, or contribute to a collision between passing ships. For VHF Marine channel assignments refer to page 42 section 10.

4. GETTING STARTED

4.1 RADIO CARE

CAUTION

Before following the instructions below, insure the speaker microphone jack, antenna and battery are in place and firmly tightened. Care must be taken if the radio was dropped and a close inspection may be needed to insure the radio case and gaskets are in adequate condition.

Clean the radio with fresh water after exposure to salt water by rinsing the radio under a sink faucet or by dunking the radio in a bucket of fresh water. After washing, use a soft cloth and thoroughly dry all parts of the radio. This is to keep the rubber switches and speaker grill clean and in top operating condition.

4.2 BATTERIES AND CHARGERS

If the radio has never been used, or its charge is depleted, it may be charged by connecting the **CD-39** Charger Cradle with the **NC-88B** battery charger, as shown in the illustration. If 12V DC power is available, the optional **E-DC-19A** DC Cable with 12 V Cigarette Lighter Plug or the optional **E-DC-6** DC Cable may be used for charging the battery. The **NC-88B**, **E-DC-19A**, and **E-DC-6** will charge a completely discharged **FNB-V99LI** battery pack in about 8 hours.

The **FNB-V99LI** is a high performance Li-Ion battery providing high capacity in a compact package.

CAUTION

To avoid risk of explosion and injury, **FNB-V99LI** battery pack should only be removed, charged or recharged in non-hazardous environments.

4.2.1 BATTERY SAFETY

Battery packs for your transceiver contain Li-Ion batteries. This type of battery stores a charge powerful enough to be dangerous if misused or abused, especially when removed from the transceiver. Please observe the following precautions:

DO NOT SHORT BATTERY PACK TERMINALS: Shorting the terminals that power the transceiver can cause sparks, severe overheating, burns, and battery cell damage. If the short is of sufficient duration, it is possible to melt battery components. Do not place a loose battery pack on or near metal surfaces or objects such as paper clips, keys, tools, etc. When the battery pack is installed on the transceiver, the terminals that transfer current to the transceiver are not exposed. The terminals that are exposed on the battery pack

when it is mounted on the transceiver are charging terminals only and do not constitute a hazard.

DO NOT INCINERATE: Do not dispose of any battery in a fire or incinerator. The heat of fire may cause battery cells to explode and/or release dangerous gases.

Battery Maintenance

For safe and proper battery use, please observe the following:

- Battery packs should be charged only in non-hazardous environments;
- Use only STANDARD HORIZON-approved batteries;
- Use only a STANDARD HORIZON, (a Marine Division of VERTEX STANDARD) approved charger. The use of any other charger may cause permanent damage to the battery.
- Follow charging instructions provided with the chargers.
- Keep the battery contacts clean.

Battery Storage

Store the batteries in a cool place to maximize storage life. Since batteries are subject to self-discharge, avoid high storage temperatures that cause large self-discharge rates. After extended storage, a full recharge is recommended.

Battery Recycling

**DO NOT PLACE USED BATTERIES IN YOUR REGULAR TRASH!
LI-ION BATTERIES MUST BE COLLECTED, RECYCLED OR DISPOSED
OF IN AN ENVIRONMENTALLY SOUND MANNER.**

The incineration, land filling or mixing of Li-Ion batteries with the municipal solid waste stream is PROHIBITED BY LAW in most areas.

Return batteries to an approved Li-Ion battery recycler. This may be where you purchased the battery.

Contact your local waste management officials for other information regarding the environmentally sound collection, recycling and disposal of Li-Ion batteries.

4.2.2 BATTERY INSTALLATION / REMOVAL

1. To install the battery pack, insert the battery pack into the battery rest on the bottom of the transceiver, then turn the Battery Pack Lock to the “**LOCK**” position with a coin.
2. To remove the battery pack, turn the transceiver off, open the Battery Pack Lock on the bottom of the transceiver, then slide out the battery from the transceiver.

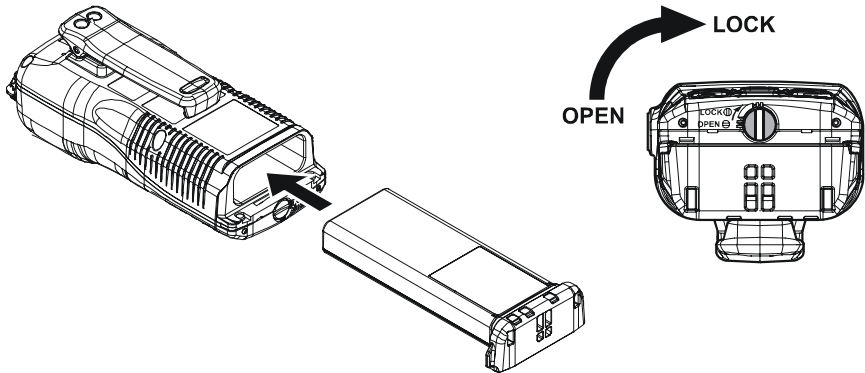

NOTE

The battery lock must be set to “**LOCK**” position to ensure water integrity and from the battery coming loose.

BELT CLIP INSTALLATION / REMOVAL

INSTALLATION

Install the Belt Clip as shown below.

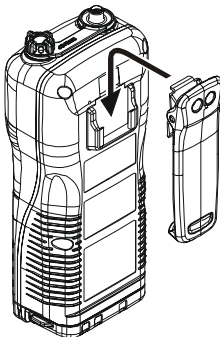

REMOVAL

Pulling the Belt Clip toward up (②) while pulling the top edge of the Belt Clip toward back (①).

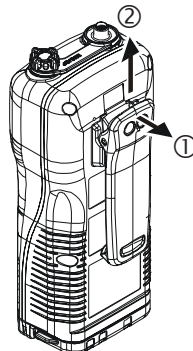

4.2.3 BATTERY CHARGING

1. Turn the transceiver off.
2. Insert the DC plug from the **NC-88B** into the DC jack on the **CD-39** side panel, then plug the **NC-88B** into the AC line outlet.
3. Insert the **HX760S** (with the battery pack) into the **CD-39**; the antenna should be at the left side when viewing the charger from the front.
4. If the **HX760S** is inserted correctly, the Red "**CHARGING**" indicator will glow. A fully-discharged pack will be charged completely in approximately 8 hours.
5. When charging is completed, the red LED indicator will change to green.

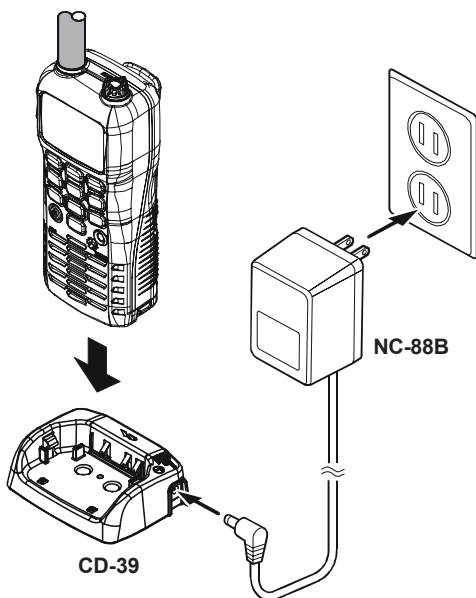

CAUTION

The **CD-39** is NOT designed to be waterproof. Do not attempt to charge in water hazardous locations.

NOTE

The **CD-39** is only designed for the charging of the **HX760S**'s battery, and is not suitable for other purposes. The **CD-39** may contribute noise to TV and radio reception in the immediate vicinity, so we do not recommend its use adjacent to such device.

5. CONTROLS AND INDICATORS

5.1 CONTROLS AND SWITCHES

NOTE

This section defines each control of the transceiver. For detailed operating instructions, refer to section 6 “**BASIC OPERATION**”. Refer to illustrations for the location of the following controls, switches, and connections.

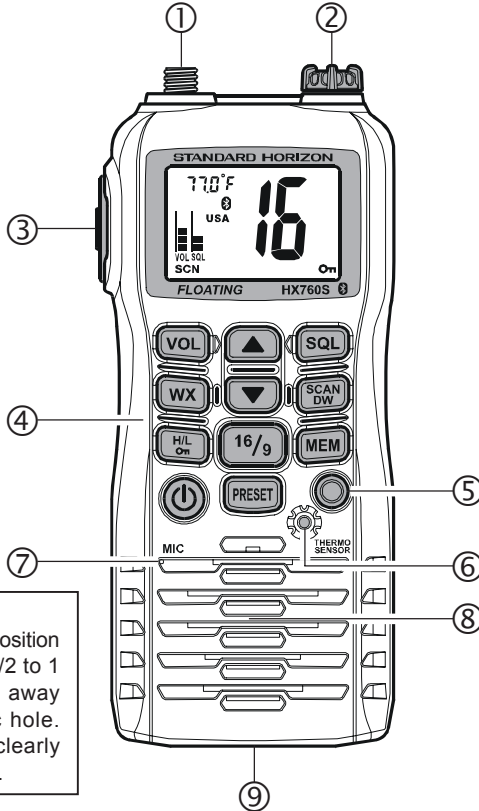

NOTE

When transmitting, position your mouth about 1/2 to 1 inch (1.2 ~ 2.5 cm) away from the small mic hole. Speak slowly and clearly into the microphone.

① ANT Jack (Top Panel)

The supplied **CAT460** flexible antenna is attached here.

② MIC/SP Jack (Top Panel)

The jack accepts the optional **CMP460** Speaker/Microphone, **MH-73A4B** Speaker/Microphone, **MH-57A4B** Mini Speaker/Microphone, **VC-24** VOX Headset, or **VC-27** Earpiece/Microphone. When this jack is used, the internal speaker and microphone are disabled.

③ **PTT (PUSH-TO-TALK) Switch**
When pushed activates the transmitter.

④ **Keypad**

[VOL] Key

Press this key to activate the volume adjusting mode. Press the [▼] or [▲] key to adjust the receiver audio volume level.

[SQL] Key

Press this key to activate the squelch adjusting mode. Press the [▼] or [▲] key to adjust the squelch threshold level.

Press and hold this key for 3 seconds to open the squelch, allowing you to monitor the operating channel. Release the key to resume normal (quiet) monitoring.

[▲(UP)] Key

This key is used to change the operating channel, receiver volume level, and squelch threshold level.

Press the key momentarily, the channel (or level) increases one step. Holding the key, the channel (or level) increases continuously.

[▼(DOWN)] Key

This key is used to change the operating channel, receiver volume level, and squelch threshold level.

Press the key momentarily, the channel (or level) decreases one step. Holding the key, the channel (or level) decreases continuously.

[WX] Key

Immediately recalls the last-used NOAA (National Oceanic and Atmospheric Administration) Weather Channel from any channel location. Recalls the previously- selected working channel when the [WX] key is pressed again.

Secondary use:

When the [16/9] key is held and the [WX] key is pressed, the radio will change the marine band between the USA, International, and Canadian channels.





[SCAN(DW)] Key

Starts scanning and priority scanning of programmed channels. When scanning, press and hold this key to turn on and off priority scan ("P" icon is shown on the bottom left side of the display during Priority scanning).

[H/L()] Key

Press this key to toggle the transmitter output power between “Normal” (6 Watts), “High” (5 Watts), “Medium” (2.5 Watts), and “Low” (1 Watt) power. This key does not function on the “Transmission Inhibited” and “Low power only” channels.

Secondary use:

Hold down this key to lock the keypad (except the **PTT**, [**VOL**], [**SQL**], [**POWER**()], and [H/L()] keys) so that they are not accidentally changed. The “” icon will appear at the bottom right corner on the display, to indicate that the functions are locked. Hold down this key until the “” icon disappears to unlock the radio.

[16/9] Key

Pressing this key immediately recalls channel 16 from any channel location. Holding down this key recalls channel 9. Pressing this key again reverts to the previous selected working channel.

[MEM] Key

Press this key to memorize the selected channel for scanning. When pressed a “MEM” icon will be shown on the LCD display indicating the channel has been saved to scan memory. The scan memory is only used with the Marine and WX channels.

To delete the channel from scan memory, select the channel and press this key until “MEM” is removed from the display.

Secondary use:

To enable the SOS Strobe light, turn off radio, press and hold this key while turning on. To turn off strobe light, turn radio off and back on.

[POWER()] Key

Press and hold this orange key for three seconds to toggle the transceiver’s power on and off.

[PRESET] Key

Immediately recalls one of up to 10 user preset memories for each band (shown as “0” - “9” on the LCD). Pressing this key repeatedly scrolls through the preset memory channels.

⑤ TX/BUSY Indicator

This indicator glows green when a signal is being received and red when transmitting.

When the Emergency feature is activated, this indicator blinks the internationally-recognized Morse Code “S.O.S” message.

⑥ Thermo Sensor

To measure a water temperature, soak the radio so the sensor is covered by water for several minutes to see the actual water temperature.

NOTE

It may take a few minutes for the temperature to register correctly.

NOTE

The temperature sensor may not display the correct temperature when the internal temperature of the radio is too hot; for example, while transmitting a lot so the radio becomes hot.

⑦ Microphone

The internal microphone is located here.

NOTE

When transmitting, position your mouth about 1/2 to 1 inch (1.2 ~ 2.5 cm) away from the small mic hole. Speak slowly and clearly into the microphone.

⑧ Speaker

The internal speaker is located here.



⑨ Battery Pack Lock (Bottom side)

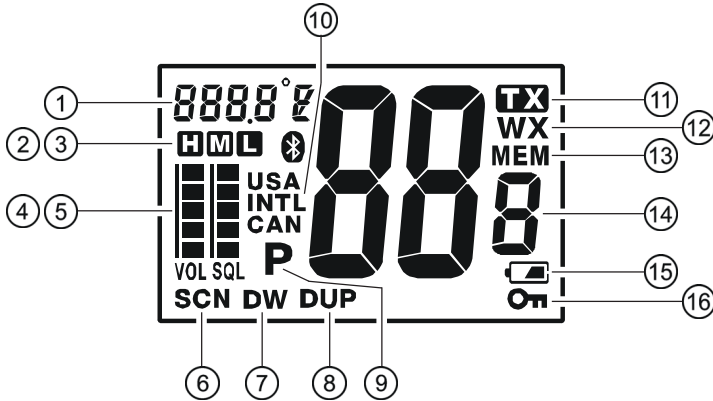

Turn the Battery Pack Lock to the “**OPEN**” position for battery removal.



5.2 INDICATORS



- ① **Information Bar**
The temperature or battery voltage is shown here.
- ② **H/M/L Indicators**
“**H**” indicates High power (5 Watts); “**M**” indicates Medium power (2.5 Watts); and “**L**” is for Low power (1 Watt). “Blank” in this location indicates Normal power (6 Watts).
- ③ **Bluetooth® (“”) Indicator**
This indicator shows the status of the optional **BH-2 Bluetooth®** Head Set.
Shown continuously: the **HX760S** recognize the **BH-2**.
Blinks slowly: the **HX760S** is recognizing the **BH-2**.
Blinks fast: the battery voltage of the **BH-2** is Low.
- ④ **VOL Indicator**
This indicator shows the receiver audio volume level.
- ⑤ **SQL Indicator**
This indicator shows the squelch level.
- ⑥ **“SCN” Indicator**
This indicator appears when the Scan is activated.
- ⑦ **“DW” Indicator**
This indicator appears when the Dual Watch is activated.
- ⑧ **“DUP” Indicator**
This indicator appears when the Duplex Channel is selected.

- ⑨ **“P”** Indicator
This indicator shows the channel is in the “Priority Channel”.
- ⑩ **USA/INTL/CAN** Indicator
These indicators show the “band” of operation for the particular channel. **“USA”** indicates the USA band; **“INTL”** indicates the International band; and **“CAN”** indicates the Canadian band.
- ⑪ **“TX”** Indicator
This indicator appears during transmission.
- ⑫ **“WX”** Indicator
This indicator appears when a NOAA weather channel is selected.
- ⑬ **“MEM”** Indicator
This indicator shows the channel is in the transceiver’s “Scan Memory”.
- ⑭ **Channel Display**
The operating channel is shown on the LCD in both the transmission and reception modes.
- ⑮ **“”** Battery Indicator
When the battery charge is almost depleted, a “” icon will appear on the display. When this icon appears, it is recommended that you charge the battery soon.

No Icon	Full battery
	Lower battery
	Battery is low
 (Blinking)	Prepare to charge the battery

- ⑯ **“”** Indicator
When the “” icon is shown on the LCD, all keys are disabled except for the **PTT**, **[VOL]**, **[SQL]**, **[POWER(

HX760S**

6. BASIC OPERATION

6.1 PROHIBITED COMMUNICATIONS

The FCC prohibits the following communications:

- False distress or emergency messages;
- Messages to “any boat” except in emergencies and radio tests;
- Messages to or from a vessel on land;
- Transmission while on land;
- Obscene, indecent, or profane language (potential fine of \$10,000).

6.2 INITIAL SETUP

1. Install the battery pack on the transceiver (see section “4.2.2 BATTERY INSTALLATION/REMOVAL”).
2. Install the antenna onto the transceiver; hold the bottom end of the antenna, the screw it onto the mating connector on the transceiver until it is snug. Do not over-tighten.

NOTE

Water resistance of the transceiver is assured only when the battery pack is attached to the transceiver and **MIC/SP** cap is installed in the **MIC/SP** jack.

6.3 RECEPTION

1. Press and hold the **[POWER(⏻)]** key for two seconds to turn the transceiver on. The DC supply voltage will be indicated on the display for 2 seconds.
2. Press the **[SQL]** key to activate the squelch adjusting mode. Press the **[▼]** key until the SQL level is “00”, then press the **[SQL]** key again (or wait 3 seconds to exit from the squelch adjusting mode). This state is known as “Squelch Off”.
3. Press the **[VOL]** key to activate the volume adjusting mode. Press the **[▼]/[▲]** key until the noise or audio from the speaker is at a comfortable level, then press the **[VOL]** key again (or wait 3 seconds to exit from the volume adjusting mode).
4. Press the **[SQL]** key, then press the **[▲]** key until the random noise disappears. This state is known as the “Squelch Threshold”.
5. Press the **[▼]** or **[▲]** key to select the desired channel. Refer to the channel chart on page 42 for available channels.

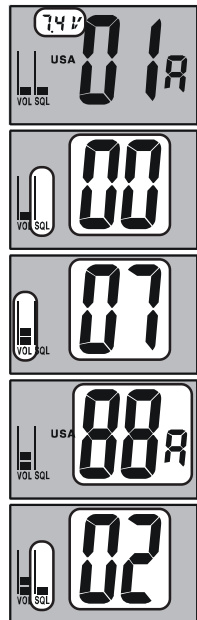

- When a signal is received, adjust the volume (Press the [VOL] key, followed by the [▼]/[▲] key) to desired listening level. The TX/BUSY indicator illuminates green indicating that the channel is being used.

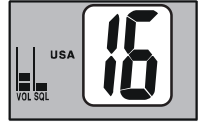

NOTE

You may change the speaker audio to have a high or lower sounding pitch to assist listening in quiet or noisy environments. See Menu item “02 PC (AUDIO PITCH CONTROL)” (page 36) for details.

6.4 TRANSMISSION

- Perform the “6.3 RECEPTION” discussion above.
- Before transmitting, monitor the channel and make sure it is clear.

THIS IS AN FCC REQUIREMENT!

- For communications over short distances, press the [H/L (🔊)] key until “1” is displayed on the LCD. This indicates Low power (approximately 1 watt).

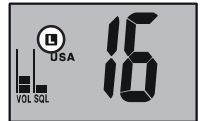

Note: Transmitting on 1 watt prolongs battery life. Low power (1 watt) should be selected whenever possible.

- If using Low power is not effective, select Medium power (2.5 watts: “2” icon appears), High power (5 watts: “3” icon appears), or Normal power (6 watts: No icon) by pressing the [H/L (🔊)] key.



- When receiving a signal, wait until the incoming signal stops before transmitting. The transceiver cannot transmit and receive simultaneously.
- Press the PTT (Push-To-Talk) switch to transmit. During transmission, the “TX” indicator will appear on the display and the TX/BUSY indicator will grow red.
- Position your mouth about 1/2 to 1 inch (1.2 ~ 2.5 cm) away from the small mic hole. Speak slowly and clearly into the microphone.
- When the transmission is finished, release the PTT switch.

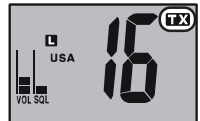

6.4.1 TRANSMIT TIME - OUT TIMER (TOT)

While the PTT switch is held down, transmission time is limited to 5 minutes. This prevents prolonged (unintentional) transmissions. About 10 seconds before automatic transmitter shutdown, a warning beep sounds from the speaker. The transceiver automatically switches to the receiving mode, even if the PTT switch is held down. Before transmitting again, the PTT switch must first be released, then wait 10 seconds and then pressed again. This Time-Out-Timer (TOT) prevents a continuous transmission that would result from an accidentally stuck PTT switch.

NOTE

The **PTT** switch is ignored for 10 seconds after the transceiver automatically switches to the receiving mode by the TOT feature.

6.5 USA, CANADIAN, AND INTERNATIONAL CHANNELS

1. To change from US to International or Canadian Marine Channels, hold down the [16/9] key and press the [WX] key. The band will change from USA, to International, and to Canadian with each press.
2. “USA” appears on the LCD for the USA band, “INTL” appears for the International band, and “CAN” appears for the Canadian band
3. Refer to the marine channel charts in section “10 VHF MARINE CHANNEL ASSIGNMENTS” for allocated channels.

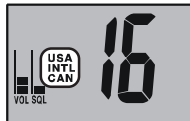

6.6 SIMPLEX/DUPLEX CHANNEL USE

Refer to the VHF MARINE CHANNEL CHART (page 42) for instructions on use of simplex and duplex channels.

NOTE

All channels are factory-programmed in accordance with FCC (USA), Industry Canada and International regulations. The mode of operation cannot be altered from simplex to duplex or vice-versa. Simplex (ship to ship) or duplex (marine operator) mode is automatically activated, depending on the channel and whether the USA, International or Canadian operating band is selected.

6.7 KEYPAD LOCKING

In order to prevent accidental channel change, the **HX760S**'s keypad may be locked out.

Hold down the [H/L(On)] key to lock the keypad (except the **PTT**, [VOL], [SQL], [POWER(⏻)], and [H/L(On)] keys) so that they are not accidentally changed. The “On” icon will appear at the bottom right corner on the display, to indicate that the functions are locked.

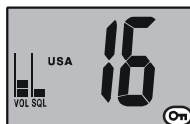

Hold down the [H/L(On)] key until the “On” icon disappears to unlock the radio.

6.8 NOAA WEATHER CHANNELS

1. To receive a NOAA (National Oceanic and Atmospheric Administration) weather broadcast, press the [WX] key. The transceiver changes to the weather channel mode. This mode consists of a preset memory bank containing the NOAA weather channels.
2. When the [WX] key is pressed, the transceiver will be set to the last used NOAA weather channel. Press the [▼] or [▲] key to change to other weather channels.
3. To exit from the weather channel mode, press the [WX] key. The transceiver will revert to the channel you were using prior to switching to the weather channel mode.



6.8.1 NOAA WEATHER ALERT

In the event of extreme weather disturbances such as storms and hurricanes, NOAA sends a “weather alert” consisting of a 1050 Hz tone, followed by weather reports on the weather channels.

When a “weather alert” is received on a weather channel, the transceiver emits a beep tone and the **TX/BUSY** indicator blinks white. Press the [WX] key to stop the beep tone and listen to the weather reports.

NOTE

Options for the Weather Alert feature are available, refer to Menu Mode Item “**13 ALt (WX ALERT)**” on page 38 for details.

6.8.2 NOAA WEATHER ALERT TESTING

In the event of a major storm or other appreciable weather condition requiring vessels at sea (or other bodies of water) to be notified, the NOAA (National Oceanographic and Atmospheric Administration) broadcasts a 1050 Hz tone that some VHF radios, including your **HX760S**, can detect for “**Weather Alarm**” purposes (refer to section “**6.8.1 NOAA WEATHER ALERT**” for a discussion of how to use this feature). The 1050 Hz tone, when detected, will produce a loud beep in the speaker of the **HX760S**, to signal that a Weather Alert Broadcast is being received.

In order to test this system, NOAA broadcasts the 1050 Hz tone every Wednesday sometime between 11 AM and 1 PM local time. You may use this opportunity to test your **HX760S** periodically to confirm that the Weather Alert feature is working, or for training crew members on how to configure the **HX760S** to receive the NOAA Weather Alerts.

6.9 PRESET CHANNELS (0 ~ 9): INSTANT ACCESS

Ten user assigned channels can be programmed for instant access. Pressing the [PRESET] key activates the user assigned channel bank. If the [PRESET] key is pressed and no channels have been assigned, an alert beep will be emitted twice from the speaker.

6.9.1 PROGRAMMING

1. Hold down the [PRESET] key, and press the [▼] or [▲] key (repeatedly, if necessary) until the desired channel number is displayed.
2. With the desired channel number displayed, release the [PRESET] key. The Preset Channel number “0” will appear at the right of the channel number on the display for 1 second.
3. Repeat steps 1 and 2 to program the desired channels into Preset Channels “1” ~ “9”.
4. To delete a Preset Channel, hold down the [PRESET] key and press the [▼] or [▲] key until the Preset Channel number to be deleted is displayed, then release the [PRESET] key.

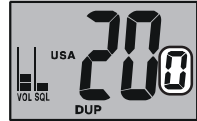

6.9.2 OPERATION

Pressing the [PRESET] key will toggle between Preset Channels “0” through “9” and the last selected “regular” channel. Preset Channel “0” is represented by “0” to the right of the channel number on the display for 1 second, and preset channel “1” is represented by “1” and so forth. The preset channel number will disappear after 1 second.

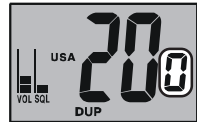

6.10 MEMORY SCAN

The **HX760S** can be programmed to scan channels from a minimum of 2 channels up to all channels in the marine band. If an incoming signal is detected on one of the channels during scan, the radio will pause on that channel, allowing you to listen to the incoming transmission.

1. Select the desired channel to be included in the scan memory using the [▼] or [▲] key.
2. Press the [MEM] key to store the channel into the transceiver's scan memory. "MEM" will be displayed on the LCD.
3. Repeat steps 1 and 2 for all the channels to be scanned.
4. To delete a channel from the transceiver's scan memory, select the memorized channel, then press the [MEM] key until "MEM" is removed from the display.
5. All channels programmed remain in the transceiver's scan memory even if the power is turned off.
6. Adjust the SQL level until background noise is eliminated by pressing the [SQL] key followed by the [▼] / [▲] key.
7. To start scanning, press the [SCAN(DW)] key. The scan proceeds from the lowest to the highest programmed channel and stops scanning when a transmission is received. Scanning will resume when the incoming signal disappears at the end of the transmission. A blinking "SCN" icon will appear at the left bottom of the display during scanning.
8. To stop the scan, press the [SCAN(DW)] key.

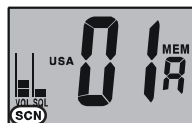
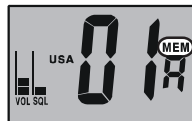

6.11 PRIORITY SCAN

The Priority Scanning feature allows the radio to Memory Scan while also keeping watch on a particularly important "Priority Channel". The following channels can be set as the Priority Channel: 16, 09, and Preset Channels described previously.

1. To set the priority channel, hold down the **[16/9]** key and press the **[MEM]** key. The channel will change from "16" to "9" to Preset Channels "0" through "9" with each press of the **[MEM]** key. When the **[16/9]** key is released the displayed channel will be set as the Priority Channel (the "P" icon will appear at the left side of the channel number).A rectangular digital display showing the number '09' in large digits. To the left of the digits, there is a small 'USA' label above a 'VOL SOL' label, and a circular icon containing a 'P'. The background of the display is light gray.
2. For Priority Scanning, press the **[SCAN(DW)]** key to activate the Memory Scanning, then hold down the **[SCAN(DW)]** key while activating the Memory Scan. Scanning will proceed between the memorized channels and the Priority Channel. The Priority Channel will be scanned after each programmed channel.
3. As an example of priority scanning, let us say that marine channels "06", "07", and "08" are memorized in the transceiver's scan memory. Priority scanning will proceed in the following sequence:
 [CH06] → [Priority Channel] → [CH07] → [Priority Channel] → [CH08] → [Priority Channel] → [CH06] → [Priority Channel]
4. Even when the transceiver stops and listens to the signal of a programmed channel, the transceiver will shift to a "dual watch" mode between this channel and the priority channel. Therefore, your priority watching of the designated channel is not compromised when the scanner has paused on an active channel.
5. To stop the Priority Scanning, press the **[SCAN(DW)]** key.

6.12 DUAL WATCH

The Dual Watch feature allows the radio watch the particularly important “Priority Channel” (determined section “6.11 PRIORITY SCAN”) and one other channel.

1. Select the desired channel using the [▼] or [▲] key.
2. Hold down the [SCAN(DW)] key for two seconds, then release the key to activate the Dual Watch feature. A small blinking “DW” icon will appear on the center bottom of the display when the Dual Watch feature is activated.
3. When a transmission is received on the “Priority Channel”, the radio receives the “Priority Channel” until the incoming signal disappears.
4. The Dual Watch feature will resume when the incoming signal disappears at the end of the transmission.
5. Press the [SCAN(DW)] key to stop the Dual Watch feature and return to normal operation.

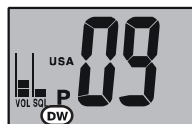

6.13 TRIPLE WATCH

The Triple Watch feature is similarly the Dual Watch feature. The Triple Watch feature watches the channel “16” and “09” while receiving the current channel.

6.13.1 SETTING UP TRIPLE WATCH FEATURE

1. Turn the transceiver off.
2. Hold down the [SQL] key, and then turn on the transceiver while still holding down the [SQL] key.
3. The “Set” will appear on the display, indicating that the Menu (“Set”) Mode has been activated.
4. Press the [SQL] key to select the Menu item “09 dt”.
5. Press the [▼] or [▲] key to select “t-”, indicating that the Triple Watch feature is selected.
6. Press the [SQL] key to save the new setting, then press the PTT switch to exit to normal operation.

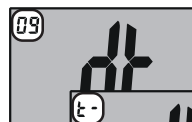

6.13.2 OPERATION

1. Select the desired channel using the [▼] or [▲] key.
2. Hold down the [SCAN(DW)] key for two seconds, then release the [SCAN(DW)] key to activate the Triple Watch feature. The radio watches the channel “16” and “09” while receiving the current channel. A small blinking “DW” icon will appear on the center bottom of the display when the Triple Watch feature is activated.

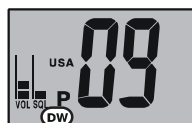

When a transmission is received on the channel “16”, the radio receives the channel “16” until the incoming signal disappears.

When a transmission is received on the channel “09”, the radio watches the channel “16” while receiving the channel “09”.

3. The Triple Watch feature will resume when the incoming signal disappears at the end of the transmission.
4. Press the [**SCAN(DW)**] key to stop the Triple Watch feature and return to normal operation.

To return to the Dual Watch operation, repeat the “**6.13.1 SETTING UP TRIPLE WATCH FEATURE**”, selecting “**d**” in step 5.

6.14 EMERGENCY (CHANNEL 16 USE)

Channel 16 is known as the Hail and Distress Channel. An emergency may be defined as a threat to life or property. In such instances, be sure the transceiver is on and set to CHANNEL 16. Then use the following procedure:

1. Press the **PTT** (Push-To-Talk) switch and say “**Mayday, Mayday, Mayday.** This is _____, _____, _____” (your vessel’s name).
2. Then repeat once: “**Mayday, _____**” (your vessel’s name).
3. Now report your position in latitude/longitude, or by giving a true or magnetic bearing (state which) to a well-known landmark such as a navigation aid or geographic feature such as an island or harbor entry.
4. Explain the nature of your distress (sinking, collision, aground, fire, heart attack, life-threatening injury, etc.).
5. State the kind of assistance your desire (pumps, medical aid, etc.).
6. Report the number of persons aboard and condition of any injured.
7. Estimate the present seaworthiness and condition of your vessel.
8. Give your vessel’s description: length, design (power or sail), color and other distinguishing marks. The total transmission should not exceed 1 minute.
9. End the message by saying “**OVER**”. Release the **PTT** switch and listen.
10. If there is no answer, repeat the above procedure. If there is still no response, try another channel.

6.15 CALLING ANOTHER VESSEL (CHANNEL 16 OR 9)

Channel 16 may be used for initial contact (hailing) with another vessel.

However, its most important use is for emergency messages. This channel must be monitored at all times except when actually using another channel.

It is monitored by the U.S. and Canadian Coast Guards and by other vessels. Use of channel 16 for hailing must be limited to initial contact only. Calling should not exceed 30 seconds, but may be repeated 3 times at 2-minute intervals. In areas of heavy radio traffic, congestion on channel 16 resulting from its use as a hailing channel can be reduced significantly in U.S. waters by using Channel 9 as the initial contact (hailing) channel for non-emergency communications. Here, also, calling time should not exceed 30 seconds but may be repeated 3 times at 2-minute intervals.

Prior to making contact with another vessel, refer to the channel charts in this manual, and select an appropriate channel for communications after initial contact. For example, Channels 68 and 69 of the U.S. VHF Charts are some of the channels available to non-commercial (recreational) boaters. Monitor your desired channel in advance to make sure you will not be interrupting other traffic, and then go back to either channel 16 or 9 for your initial contact.

When the hailing channel (16 or 9) is clear, state the name of the other vessel you wish to call and then “**this is**” followed by the name of your vessel and your Station License (Call Sign). When the other vessel returns your call, immediately request another channel by saying “**go to**”, the number of the other channel, and “**over**”. Then switch to the new channel. When the new channel is not busy, call the other vessel.

After a transmission, say “**over**”, and release the **PTT** (Push-To-Talk) switch. When all communication with the other vessel is completed, end the last transmission by stating your Call Sign and the word “**out**”. Note that it is not necessary to state your Call Sign with each transmission, only at the beginning and end of the contact.

Remember to return to Channel 16 when not using another channel. Some radios automatically monitor Channel 16 even when set to other channels or when scanning.

6.16 OPERATING ON CHANNEL 13

Channel 13 is used at docks, bridges and for maneuvering in port. Messages on this channel must concern navigation only, such as meeting and passing in restricted waters. In emergencies and when approaching blind river bends, High power is allowed. Pressing the [H/L(On)] key will change the power output from Low Power (1 Watt) to Medium (2.5 Watts), High (5 Watts), or Normal (6 Watts). When you change from this channel then return to it, low power will be automatically selected.

6.17 OPERATING ON CHANNEL 67

When channel 67 is used for navigational bridge-to-bridge traffic between ships, Normal, High or Medium power may be used temporarily (in the USA band) by pressing the [H/L(On)] key. When you select this channel again, the transceiver will revert to low power.

6.18 MEASURING WATER TEMPERATURE

The **HX760S** can measure water temperature. The measurable temperature range is 14 °F to +140 °F (–10 °C to +60 °C).

6.18.1 ACTIVATING WATER TEMPERATURE SENSOR

1. Turn the transceiver off.
2. Hold down the [SQL] key, and then turn on the transceiver while still holding down the [SQL] key.
3. “SEt” will appear on the display, indicating that the Menu (“Set”) Mode has been activated.
4. Press the [SQL] key to select the Menu item “03 dSP”.
5. Press the [▼] or [▲] key to select “Unit °C” or “Unit °F”.
Unit °C: Indicates the current temperature by °C.
Unit °F: Indicates the current temperature by °F.
6. Press the [SQL] key to save the new setting, then press the PTT switch to exit to normal operation.

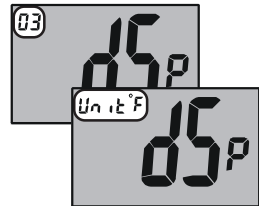
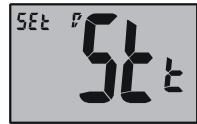

6.18.2 OPERATION

Soak the thermal sensor on the front panel of the **HX760S** in water for several minutes. The water temperature will be shown on the display.

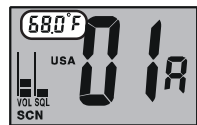

6.18.3 CALIBRATING WATER TEMPERATURE SENSOR

If the temperature display is incorrect, it can be re-calibrated via Menu Mode.

1. Turn the transceiver off.
2. Hold down the **[SQL]** key, and then turn on the transceiver while still holding down the **[SQL]** key.
3. “SEt” will appear on the display, indicating that the Menu (“Set”) Mode has been activated.
4. Press the **[SQL]** key to select the Menu item “04 tEP”.
5. Press the **[▼]** or **[▲]** key to set the difference between **HX760S** display and the calibrated thermometer.
For example, if the **HX760S** display shows “68.0 °F” and the (calibrated) thermometer indicates “65.3 °F”, set the temperature offset to “-2.7 °F”.
6. Press the **[SQL]** key to save the new setting, then press the **PTT** switch to exit to normal operation.

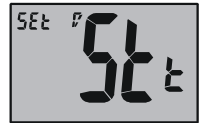

The temperature sensor may not display the correct temperature when the temperature inside the radio is high; for example, while the transmission mode or high receiver audio output.

6.19 ENABLING S.O.S STROBE OPERATION

The S.O.S. STROBE feature utilizes the high-intensity strobe LED on the front of the **HX760S** as a visual distress beacon. When enabled, the LED blinks the internationally-recognized Morse Code “S.O.S.” message (... --- ...) at a rate of 5 words per minute. This can be very useful in summoning help from rescuers who may not be able to communicate with you via radio.

1. Hold down the **[MEM]** key while turning the radio on to activate the emergency S.O.S. Strobe. Once the radio comes on, the **TX/BUSY** LED will flash the Morse Code S.O.S. message repeatedly.
2. The S.O.S. strobe function is interrupted when a signal is received or if the squelch control is turned so audio is heard from the speaker.
3. To disable the S.O.S. strobe function, turn the radio off and back on again.

7. BH-2 Bluetooth® HEAD SET OPERATION

The optional **BH-2 Bluetooth®** Head Set can communicate your voice and receiving signal to/from the **HX760S**, with the **Bluetooth®** technology.

7.1 PAIRING

Before you use your **BH-2** for the first time, the **BH-2** and the **HX760S** must be paired.

1. Make sure that the **BH-2** and **HX760S** is both off.
2. Hold down the **HX760S**'s [**SQL**] key, and then turn on the transceiver while still holding down the [**SQL**] key to activate the Menu ("Set") Mode. "SEt" will appear on the display.
3. Press the [**SQL**] key to select the Menu item "14 bt".
4. Press the [**▼**] or [**▲**] key to select desired Operation Mode of the **BH-2** (except "oFF").

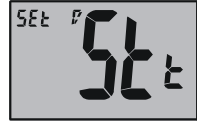

Ptt: Activates the **Bluetooth®** function without the Battery Save and VOX features.

PttSV: Activates the **BH-2** with the Battery Save feature.

If there has been no signal or key activity for 20 seconds, the Battery Saver automatically puts the **BH-2** to "sleep", to conserve battery life. When signal is received or the **PTT** switch is pressed, the **BH-2** will be active again. Furthermore, if there has been no signal or key activity for 10 minutes, turns the **BH-2** off automatically.

Hi: Activates the **BH-2** with the VOX feature (VOX gain: High).

Lo: Activates the **BH-2** with the VOX feature (VOX gain: Low).

oFF: Disable the **BH-2**.

Note: When pairing, select "Ptt", "PttSV", "Hi" or "Lo". If "oFF" is selected, it is impossible to so pairing, because the **Bluetooth®** function is not active.

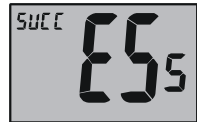
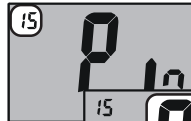

5. Press the [**SQL**] key.
6. Press the [**SQL**] key again to select the Menu item "15 Pin".
7. Press and hold the [**MEM**] key until "PAr" appears.
8. Press and hold the **POWER** switch of the **BH-2** until the LED indicator blinks red/blue alternately (approximately five seconds).
9. When the **BH-2** is correctly recognized (requires a 20 to 30 seconds) by the **HX760S**, the LED indicator of the **BH-2** will blink blue and "SUCCESS" notation will appear on the display of the **HX760S** for few seconds.

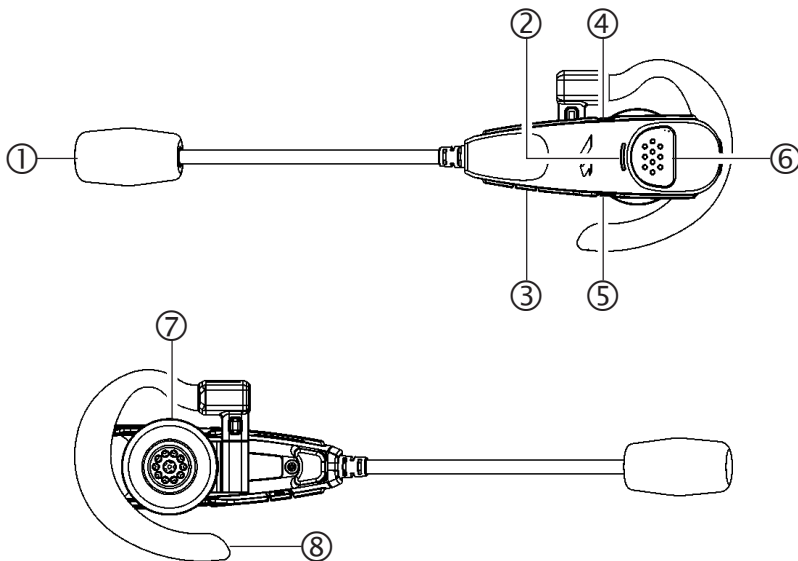

10. Press **PTT** switch of the **HX760S** to exit the **HX760S** to normal operation.
11. Turns both **BH-2** and **HX760S** off.

7.2 CONTROLS AND SWITCHES



- ① Microphone
- ② LED Indicator
 Blinking Blue: The **BH-2** is correctly recognized by the **HX760S**.
 Blinking Red: The **BH-2** is not correctly recognized by the **HX760S**.
 LED color is Red and Blue: The battery voltage of the **BH-2** is Low.
- ③ **POWER**() Switch
 Turns the **BH-2** on and off.
 To turn the **BH-2** on, press and hold this switch until the **BH-2**'s LED indicator glows red, and the beeper sounds a high pitch tone (approximately three seconds).
 To turn the **BH-2** off, press and hold this switch until the beeper sounds two brief tones (emit the one low pitch tone and then one high pitch tone), and the **BH-2**'s LED indicator glows red (approximately five seconds).
- ④ **VOLUME** () Switch
 Pressing this switch decrease the receiver volume level.
Secondary use:
 Press this switch while pressing and holding the **PTT** switch, to decreases the microphone gain of the **BH-2**.

⑤ **VOLUME (+) Switch**

Pressing this switch increase the receiver volume level.

Secondary use:

Press this switch while pressing and holding the **PTT** switch, to increases the microphone gain of the **BH-2**.

⑥ **PTT switch**

Pressing this switch cause the **HX760S** to transmit. Release this switch to return to receive the **HX760S**.

⑦ **Speaker**

⑧ **Ear Hook**

You can wear the **BH-2** on your left or right ear. (see section “**7.3.3 EAR HOOK ORIENTATION**”).

7.3 OPERATION

7.3.1 WEARING THE BH-2

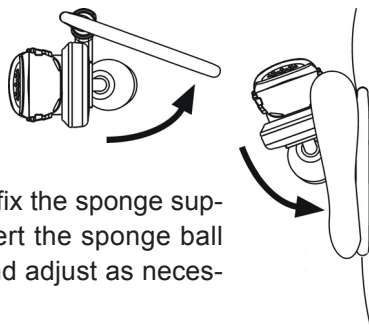

1. Open the Ear Hook.
2. Loop the Ear Hook over your ear.
3. Press the **BH-2** to your ear.
4. Adjust the flexible boom microphone by bending the boom towards your mouth.

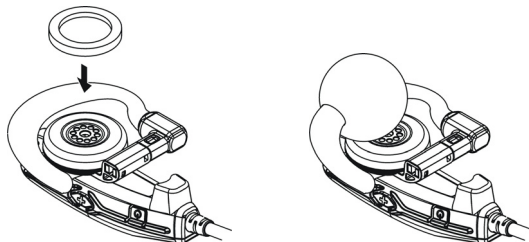

For more comfort when wearing the **BH-2**, affix the sponge supplied with the **BH-2** on the speaker and insert the sponge ball supplied with the **BH-2** into the Ear Hook, and adjust as necessary.



7.3.2 OPERATION

1. Press and hold the **HX760S**'s [**POWER**(⏻)] key for two seconds to turn the transceiver on. “” icon will blink on the display.
2. Press and hold the **BH-2**'s **POWER**(⏻) switch until the **BH-2**'s LED indicator glows red, and the beeper sounds a high pitch tone (approximately three seconds).
3. When the **BH-2** is correctly recognized by the **HX760S**, the “” icon is turned on continuously and the **BH-2**'s LED indicator blinks blue.

4. Adjust the receiver audio level by the [VOLUME(+)]/[VOLUME(-)] switches on the **BH-2**. Pressing the [VOLUME(+)] switch increase the receiver audio level. Pressing the [VOLUME(-)] switch decrease the receiver audio level.
5. Press the **PTT** switch on the **BH-2** to transmit. Release the **PTT** switch to return to receive.
6. You may adjust the microphone gain of the **BH-2** (Five steps) by pressing the [VOLUME(+)]/[VOLUME(-)] switch while pressing and holding the **PTT** switch, if desired.
Pressing the [VOLUME(+)] switch while pressing and holding the **PTT** switch increase the microphone level. Pressing the [VOLUME(-)] switch while pressing and holding the **PTT** switch decrease the microphone level. When the microphone gain reaches maximum or minimum, a beep will be heard in the **BH-2** speaker.
7. The communication range between the **BH-2** and **HX760S** is around 10 m (33 ft). If you move out the range, a beep will be heard from the **BH-2** to alert you. If you move back into range, the **BH-2** will beep to alert you are back within range.
8. When the battery voltage of the **BH-2** is low;
 - a. the LED will illuminate Red and Blue and be blinking.
 - b. a beep will be heard from the **BH-2**.
 - c. the “

NOTE

When the **BH-2** is correctly recognized, the **HX760S**'s internal speaker, microphone, and [VOL] key are disabled.

7.3.3 EAR HOOK ORIENTATION

The **BH-2** comes ready to fit the left ear. You may change the **BH-2** to fit the right ear in the following procedure.

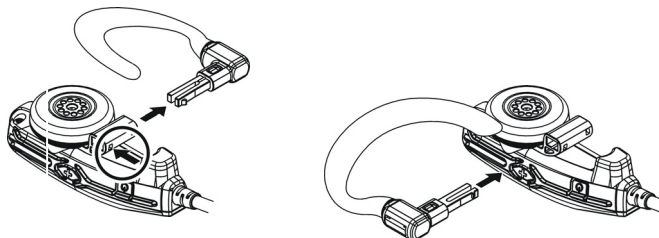

1. The Ear Hook is removed by pushing it out with a pointed object.
2. Removed Ear Hook is inserted from the other side.



8. MENU (“SET”) MODE

The **HX760S**'s Menu Mode allows a number of the **HX760S** operating parameters to be custom-configured for your operating requirements.

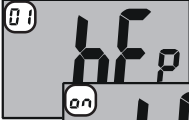
The Menu Mode is easy to activate and set, using the following procedure:

1. Turn the transceiver off.
2. Hold down the [**SQL**] key, and then turn on the transceiver while still holding down the [**SQL**] key.
3. “**SEt**” will appear on the display, indicating the Menu (“Set”) Mode has been activated. 
4. Press the [**SQL**] key to select the Menu item to be adjusted. 
5. Press the [**▼**] or [**▲**] key to enable adjustment of the selected Menu item. The menu item will blink. 
6. Press the [**SQL**] key to select the status or value of the Menu item.
7. After completing your adjustment, press the **PTT** switch to save the new setting and exit to normal operation.

01 bEP (BEEP)

Function: Enable/Disable the Keypad beeper.

Available Values: on / oFF

Default: on



02 PC (AUDIO PITCH CONTROL)

Function: This control changes the speaker audio to have a high or lower sounding pitch to assist listening in quiet or noisy environments.

Available Values: on / oFF

Default: oFF



03 dSP (DISPLAY MODE)

Function: Select the display of the sensor unit's information.

Available Values: Unit °C / Unit °F / V / oFF

Default: oFF

Unit °C: Indicates the current temperature by °C.

Unit °F: Indicates the current temperature by °F.

V: Indicates the battery voltage.

oFF: Disables the temperature and voltage indication.



04 tEP (TEMP ADJUST)

Function: Calibrating the Thermometer setting

Available Values: -9.9 ~ +9.9

Default: 0.0

See page 31 for details.



05 LP (LAMP MODE)

Function: Selects the Lamp illumination method for the LCD/Keypad.

Available Values: Cnt / kEY / off

Default: kEY

kEY: Illuminates the LCD/Keypad for 5 seconds when any key is pressed.

Cnt: Illuminates the LCD/Keypad continuously.

Off: Turns off the backlight for the LCD and keys.



06 dr (DIMMER)

Function: Adjusting of the display brightness

Available Values: 00 / 01 / 02 / 03

Default: 02



07 SnL (SCAN LAMP)

Function: Enable/Disable the automatic illumination of the lamp when a signal is received on a channel during Scanning

Available Values: on / oFF

Default: oFF



08 SCn (SCAN DISPLAY)

Function: Selects the Scanning display mode

Available Values: nor (Normal) / SPL (Special)

Default: nor (Normal)

When this menu is set to “nor (Normal)”, the channel numbers during scan will be shown as scrolling on the display. When “SPL (Special)” is selected the channel numbers on the display do not change unless a call was received. The channel shown is the last channel that was received.



09 dt (DUAL WATCH MODE)

Function: Selects dual or tri-watch as desired.

Available Values: d- (Dual Watch) / t- (Triple Watch)

Default: d- (Dual Watch)

See page 27 for details.



10 dUL (DW DISPLAY)

Function: Selects the Dual Watch scanning display mode.

Available Values: nor (Normal) / SPL (Special)

Default: nor (Normal)

When “SPL (Special)” is selected the channel shown on the display is the last channel the **HX760S** received a call on. This is a handy feature if you cannot look at the radio the moment a transmission was received.



11 bSY (BUSY LED)

Function: Enable/Disable the **BUSY** LED while the squelch is open.

Available Values: on / oFF

Default: on



12 SOS (STROBE ILLUMINATION)

Function: Selects the S.O.S Strobe illumination from continuously on to SOS Strobe.

Available Values: SoS / Cnt (Continuous)

Default: SoS

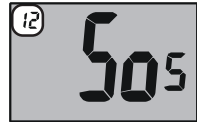

13 ALt (WX ALERT)

Function: Enable/Disable the Weather Alert feature.

Available Values: on / SCn / on SC / oFF

Default: on SC

on: When on a weather channel, the radio will alarm when the Weather Alert is received.

Scn: Emits a load beep when the Weather Alert is received while scanning the Weather channels.

on SC: Emits a load beep when the Weather Alert is received while receiving the Weather channel and/or scanning the Weather channels.

oFF: Disable the Weather Alert function.



14 bt (BLUETOOTH®)

Function: Selects the Operating Mode of the optional **BH-2 Bluetooth®** Head Set.

Available Values: Ptt / PttSV / Hi / Lo / oFF

Default: oFF



Ptt: Activates the **Bluetooth®** function without the Battery Save and VOX features.

PttSV: Activates the **Bluetooth®** function with the Battery Save feature. If there has been no signal or key activity for 20 seconds, the Battery Saver automatically puts the **BH-2** to “sleep”, to conserve battery life. When signal is received or the **PTT** switch is pressed, the **BH-2** will be active again.

Hi: Activates the **Bluetooth®** function with the VOX gain set to High.

Lo: Activates the **Bluetooth®** function with the VOX gain set to Low.

oFF: The **Bluetooth®** function is turned off.

15 Pin (PIN CODE)

Function: Pairing the **Bluetooth®** unit and setting the Pin Code.

Default: 6111

See page 32 for details.



9. MAINTENANCE

9.1 GENERAL

The inherent quality of the solid-state components in STANDARD HORIZON radios will provide many years of continuous use. Take the following precautions to prevent damage to the radio.

- To prevent corrosion of electrical contacts and keep the water resistance, keep the microphone connected or the jack covered at all times.
- Never key the transmitter unless an antenna or suitable dummy load is connected to the antenna receptacle.
- Ensure that the input voltage does not exceed the value specified in your Owner's Manual.
- Use only STANDARD HORIZON-approved accessories and replacement parts.

9.2 REPLACEMENT PARTS

Occasionally an owner needs a replacement part. These can be ordered from our Parts Department by writing or calling:

Marine Division of Vertex Standard
US Headquarters
10900 Walker Street, Cypress, CA 90630, U.S.A.
Telephone (714) 827-7600

Commonly requested parts, and their part numbers are listed below.

- **CD-39** Charger Cradle: AAF94X001
- **CAT460** Antenna: Q3000176
- **CLIP-19** Belt Clip: CP9196001
- **MIC/SP** Cap: RA1087000
- **MIC/SP** Cap O-Ring: RA046760A
- **MIC/SP** Rubber: RA1030500
- **BH-2** Ear Hook: S8002323
- **BH-2** Ear Hook Sponge: S8002325
- **BH-2** Speaker Sponge: S8002324
- **BH-2** Wind Screen: S8002322

9.3 TROUBLESHOOTING CHART

SYMPTOM	PROBABLE CAUSE	REMEDY
The [SCAN(DW)] key does not start the scan.	No channels memorized.	Use the [MEM] key to enter desired channels into the transceiver's memory.
	Squelch is not adjusted.	Adjust the squelch to threshold or to the point where noise just disappears. Further adjustment of the squelch control may eliminate incoming signals.
The USA/INTL/CAN modes do not function.	Proper operation not followed.	HOLD down the [16/9] key and press the [WX] key.
Press and holding the [SQL] switch does not eliminate background noise.	Low battery.	Charge battery. Refer to section 4 of this manual.
	Audio volume level is too low.	Press the [VOL] key and press the [▲] key several times.
Cannot change any function.	Key Lock is on.	Turn Key Lock off. Refer to section 5, ④ [H/L(On)] key.
Key Lock does not function.	Proper operation not followed.	Hold down the [H/L(On)] key for 2 seconds.
Indicator does not light when charging a battery.	Defective battery FNB-V99LI .	Contact your Standard Horizon dealer.

10. VHF MARINE CHANNEL ASSIGNMENTS

Tables on the following pages list the VHF Marine Channel assignments for U.S.A. and International use. Below are listed some data about the charts.

1. VTS. Where indicated, these channels are part of the U.S. Coast Guard's Vessel Traffic System.
2. Alpha channel numbers, that is, channel numbers followed by the letter A (such as Channel 07A) are **simplex** channels on the U.S.A. or Canadian channel assignments whose counterparts in the International assignments are **duplex** channels. International channels do not use "alpha" numbers. If you call the Coast Guard on Channel 16, they will sometimes ask you to "**go to channel 22 Alpha**." This is a channel assigned to U.S.A., and Canadian Coast Guards for handling distress and other calls. If your radio is set for **International** operation you will go to Channel 22 instead of 22A, and will not be able to communicate with the Coast Guard. To use Channel 22A, your radio must be set for **USA** or **Canada** operation, usually by a U/I/C (USA/International/Canada) control or combination of controls. Channel 22 (without an "A") is an **International** duplex channel for port operations. Some radios indicate an "A" adjacent to the alpha channels on the display; on others "alpha" is not indicated but the proper channel is selected based on the U/I/C setting.
3. Bridge-to-Bridge channels (for example, Channel 13) are for use by bridge operators on inter-coastal waterways and rivers. It is also used by marine vessels in the vicinity of these bridges for navigation and for communicating with the bridge operators. Note that a limit of 1 Watt is specified for these channels.
4. The **S/D** column on the chart indicates either S (simplex) or D (duplex). **Simplex** means transmitting and receiving on the same frequency. Only one party at a time can talk, unlike a telephone. Be sure to say "**over**" and release your microphone push-to-talk switch at the end of each transmission. **Duplex** operation involves the use of one frequency for transmitting and a separate frequency for receiving. On channels specified as duplex on the charts, correct mode of operation is established automatically by your radio when you select a channel; you cannot change the mode. And you still must release the push-to-talk switch after each transmission in order to listen to the radio.
5. Channels normally used by recreational boaters are those that include the term "non-commercial" in the **Channel Use** column of the chart. Some of these are shared with other users and some are used only in certain geographic regions.

6. **Marine vessels equipped with VHF radios are required to monitor Channel 16.**

VHF MARINE CHANNEL CHART								
CH	U	C	I	S/D	TX	RX	CHANNEL USE	
01		X	X	D	156.050	160.650	Public Correspondence (Marine Operator)	
01A	X			S	156.050		Port Operation and Commercial. VTS in selected areas	
02		X	X	D	156.100	160.700	Public Correspondence (Marine Operator)	
03		X	X	D	156.150	160.750	Public Correspondence (Marine Operator)	
03A	X			S	156.150		U.S. Government Only, Coast Guard	
04			X	D	156.200	160.800	Public Correspondence (Marine Operator), Port operation, ship movement	
04A		X		S	156.200		Pacific coast: Coast Guard, East Coast: Commercial fishing	
05			X	D	156.250	160.850	Public Correspondence (Marine Operator), Port operation, ship movement	
05A	X	X		S	156.250		Port operation. VTS in Seattle	
06	X	X	X	S	156.300		Inter-ship Safety	
07			X	D	156.350	160.950	Public Correspondence (Marine Operator), Port operation, ship movement	
07A	X	X		S	156.350		Commercial	
08	X	X	X	S	156.400		Commercial (Inter-ship only)	
09	X	X	X	S	156.450		Boater Calling channel, Commercial & Non-commercial (Recreational)	
10	X	X	X	S	156.500		Commercial	
11	X	X	X	S	156.550		Commercial. VTS in selected areas.	
12	X	X	X	S	156.600		Port operation. VTS in selected areas.	
13	X	X	X	S	156.650		Inter-ship Navigation Safety (Bridge-to-bridge)	
14	X	X	X	S	156.700		Port operation. VTS in selected areas.	
15	X			S	--	156.750	Environmental (Receive only)	
15		X	X	S	156.750		Commercial, non-commercial, ship movement (1 W)	
16	X	X	X	S	156.800		International Distress, Safety and Calling	
17	X	X	X	S	156.850		State Controlled (1 W)	
18			X	D	156.900	161.500	Port operation, ship movement	
18A	X	X		S	156.900		Commercial	
19			X	D	156.950	161.550	Port operation, ship movement	
19A	X			S	156.950		US: Commercial	
19A		X		S	156.950		Coast Guard	
20	X	X	X	D	157.000	161.600	Canadian Coast Guard Only, International: port operations and shipment	
20A	X			S	157.000		Port operation	
21			X	D	157.050	161.650	Port operation, ship movement	
21A	X	X		S	157.050		U.S. Government Only, Canadian Coast Guard	
22			X	D	157.100	161.700	Port operation, ship movement	
22A	X	X		S	157.100		US and Canadian Coast Guard Liaison and Maritime Safety Information Broadcasts announced on channel 16	
23		X	X	D	157.150	161.750	Public Correspondence (Marine Operator)	
23A	X			S	157.150		U.S. Government Only	
24	X	X	X	D	157.200	161.800	Public Correspondence (Marine Operator)	
25	X	X	X	D	157.250	161.850	Public Correspondence (Marine Operator)	
26	X	X	X	D	157.300	161.900	Public Correspondence (Marine Operator)	
27	X	X	X	D	157.350	161.950	Public Correspondence (Marine Operator)	
28	X	X	X	D	157.400	162.000	Public Correspondence (Marine Operator)	

VHF MARINE CHANNEL CHART							
CH	U	C	I	S/D	TX	RX	CHANNEL USE
60		X	X	D	156.025	160.625	Public Correspondence (Marine Operator)
61			X	D	156.075	160.675	Public Correspondence (Marine Operator), Port operation, ship movement
61A	X	X		S	156.075		Public Coast: Coast Guard; East Coast: commercial fishing only
62			X	D	156.125	160.725	Public Correspondence (Marine Operator), Port operation, ship movement
62A		X		S	156.125		Public Coast: Coast Guard; East Coast: commercial fishing only
63			X	D	156.175	160.775	Public Correspondence (Marine Operator), Port operation, ship movement
63A	X	X		S	156.175		Port Operation and Commercial. VTS in selected areas.
64		X	X	D	156.225	160.825	Public Correspondence (Marine Operator), Port operation, ship movement
64A	X	X		S	156.225		Public Correspondence (Marine Operator), Port operation, ship movement
65			X	D	156.275	160.875	Public Correspondence (Marine Operator), Port operation, ship movement
65A	X	X		S	156.275		Port Operations
66			X	D	156.325	160.925	Public Correspondence (Marine Operator), Port operation, ship movement
66A	X	X		S	156.325		Port Operations
67	X	X	X	S	156.375		US: Commercial. Used for Bridge-to-bridge com- muni-cations in lower Mississippi River. Inter-ship only, Canada: Commercial fishing, S&R
68	X	X	X	S	156.425		Non-commercial (Recreational)
69	X	X	X	S	156.475		US: Non-commercial (Recreational), Canada: Commercial fishing only, International: Inter-ship, Port operations and Ship movement
70	X	X	X	S	156.525		Digital selective calling (voice communications not allowed)
71	X	X	X	S	156.575		US, Canada: Non-commercial (Recreational), International: Port operations and Ship movement
72	X	X	X	S	156.625		Non-commercial (Inter-ship only)
73	X	X	X	S	156.675		US: Port Operations, Canada: Commercial fish ing only, International: Inter-ship, Port operations and Ship movement
74	X	X	X	S	156.725		US: Port Operations, Canada: Commercial fishing only, International: Inter-ship, Port operations and Ship movement
75	X	X	X	S	156.775		Port Operations (Inter-ship only) (1W)
76	X	X	X	S	156.825		Port Operations (Inter-ship only) (1W)
77	X	X		S	156.875		Port Operations (Inter-ship only) (1W)
77			X	S	156.875		Port Operations (Inter-ship only)
78			X	D	156.925	161.525	Public Correspondence (Marine Operator), Port operation, ship-movement
78A	X	X		S	156.925		Non-commercial (Recreational)
79			X	D	156.975	161.575	Port operation and Ship movement
79A	X	X		S	156.975		Commercial

VHF MARINE CHANNEL CHART							
CH	U	C	I	S/D	TX	RX	CHANNEL USE
80			X	D	157.025	161.625	Port operation, ship movement
80A	X	X		S	157.025		Commercial
81			X	D	157.075	161.675	Port operation, ship movement
81A	X			S	157.075		U.S. Government Only - Environmental protection operations.
81A		X		S	157.075		Canadian Coast Guard Only
82			X	D	157.125	161.725	Public Correspondence (Marine Operator), Port operation, ship movement
82A	X	X		S	157.125		U.S. Government Only, Canadian Coast Guard Only
83		X		D	157.175	161.775	Canadian Coast Guard Only
83			X	D	157.175	161.775	Public Correspondence (Marine Operator)
83A	X	X		S	157.175		U.S. Government Only, Canadian Coast Guard Only
84	X	X	X	D	157.225	161.825	Public Correspondence (Marine Operator)
85	X	X	X	D	157.275	161.875	Public Correspondence (Marine Operator)
86	X	X	X	D	157.325	161.925	Public Correspondence (Marine Operator)
87		X	X	S	157.375		Port operation, ship movement
87A	X			S	157.375		Public Correspondence (Marine Operator)
88		X	X	S	157.425		Port operation, ship movement
88A	X			S	157.425		Commercial, Inter-ship Only
WX01	X	X	X	D	---	162.550	Weather (receive only)
WX02	X	X	X	D	---	162.400	Weather (receive only)
WX03	X	X	X	D	---	162.475	Weather (receive only)
WX04	X	X	X	D	---	162.425	Weather (receive only)
WX05	X	X	X	D	---	162.450	Weather (receive only)
WX06	X	X	X	D	---	162.500	Weather (receive only)
WX07	X	X	X	D	---	162.525	Weather (receive only)
WX08	X	X	X	D	---	161.650	Weather (receive only)
WX09	X	X	X	D	---	161.775	Weather (receive only)
WX10	X	X	X	D	---	163.275	Weather (receive only)

NOTE: Simplex channels, 3A, 21A, 23A, 61A, 64A, 81A, 82A and 83A CANNOT be lawfully used by the general public in U.S.A. waters.

Channel designator	Carrier frequency (MHz)		Points of communication (Intership and between coast and ship unless otherwise indicated)	
	Ship transmit	Coast transmit		
Port Operations				
01A ¹	156.050	156.050	Intership only.	
63A ¹	156.175	156.175		
05 ²	156.250	156.250		
65A	156.275	156.275		
66A	156.325	156.325		
12 ³	156.600	156.600		
73	156.675	156.675		
14 ³	156.700	156.700		
74	156.725	156.725		
77 ⁴	156.875			
20	157.000	161.600		
20A ¹²	157.000			
Navigational (Bridge-to-Bridge)⁵				
13 ⁶	156.650	156.650		
67 ⁷	156.375	156.375		
Commercial				
01A ¹	156.050	156.050	Intership only. Do.	
63A ¹	156.175	156.175		
07A	156.350	156.350		
67 ⁷	156.375			
08	156.400		
09	156.450	156.450		
10	156.500	156.500		
11 ³	156.550	156.550		
18A	156.900	156.900		
19A	156.950	156.950		
79A	156.975	156.975		
80A	157.025	157.025		
88A ⁸	157.425		
72 ¹⁴	156.625		
Digital Selective Calling				
70 ¹⁵	156.525	156.525		

Channel designator	Carrier frequency (MHz)		Points of communication (Intership and between coast and ship unless otherwise indicated)	
	Ship transmit	Coast transmit		
Noncommercial				
68 ¹⁷	156.425	156.425	Intership only. Great Lakes only. Do. Internship only.	
09 ¹⁶	156.450	156.450		
69	156.475	156.475		
71	156.575	156.575		
72	156.625		
78A	156.925	156.925		
79A	156.975	156.975		
80A	157.025	157.025		
67 ¹⁴	156.375		
Distress, Safety and Calling				
16	156.800	156.800		EPRIB
Intership Safety				
06	156.300		a. Intership, or b. For SAR: Ship and aircraft for the U.S. Coast Guard.
Environmental				
15 ¹³	156.750	Coast to ship only.	
Maritime Control				
17 ^{9,10}	156.850	156.850		
Liaison, U.S. Coast Guard				
22A ¹¹	157.100	157.100	Ship, aircraft, and coast stations of the U.S. Coast Guard and at Lake Mead, Nev., ship and coast stations of the National Park Service, U.S. Department of the Interior.	

- 156.050 MHz and 156.175 MHz are available for port operations and commercial communications purposes when used only within the U.S. Coast Guard designated Vessel Traffic Services (VTS) area of New Orleans, on the lower Mississippi River from the various pass entrances in the Gulf of Mexico to Devil's Swamp Light at River Mile 242.4 above head of passes near Baton Rouge.
- 156.250 MHz is available for port operations communications use only within the U.S. Coast Guard designated VTS radio protection areas of New Orleans and Houston described in Sec. 80.383. 156.250 MHz is available for intership port operations communications used only within the area of Los Angeles and Long Beach harbors, within a 25-nautical mile radius of Point Fermin, California.
- 156.550 MHz, 156.600 MHz and 156.700 MHz are available in the U.S. Coast Guard designated port areas only for VTS communications and in the Great Lakes available primarily for communications relating to the movement of ships in sectors designated by the St. Lawrence Seaway Development Corporation or the U.S. Coast Guard. The use of these frequencies outside VTS and ship movement sector protected areas is permitted provided they cause no interference to VTS and ship movement communications in their respective designated sectors.

- 4: Use of 156.875 MHz is limited to communications with pilots regarding the movement and docking of ships. Normal output power must not exceed 1 watt.
- 5: 156.375 MHz and 156.650 MHz are available primarily for intership navigational communications. These frequencies are available between coast and ship on a secondary basis when used on or in the vicinity of locks or drawbridges. Normal output power must not exceed 1 watt. Maximum output power must not exceed 10 watts for coast stations or 25 watts for ship stations.
- 6: On the Great Lakes, in addition to bridge-to-bridge communications, 156.650 MHz is available for vessel control purposes in established vessel traffic systems. 156.650 MHz is not available for use in the Mississippi River from South Pass Lighted Whistle Buoy "2" and Southwest Pass entrance Mid-channel Lighted Whistle Buoy to mile 242.4 above Head of Passes near Baton Rouge. Additionally it is not available for use in the Mississippi River-Gulf Outlet, the Mississippi River-Gulf Outlet Canal, and the Inner Harbor Navigational Canal, except to aid the transition from these areas.
- 7: Use of 156.375 MHz is available for navigational communications only in the Mississippi River from South Pass Lighted Whistle Buoy "2" and Southwest Pass entrance Mid-channel Lighted Whistle Buoy to mile 242.4 above head of Passes near Baton Rouge, and in addition over the full length of the Mississippi River-Gulf Outlet Canal from entrance to its junction with the Inner Harbor Navigation Canal, and over the full length of the Inner Harbor Navigation Canal from its junction with the Mississippi River to its entry to Lake Pontchartrain at the New Seabrook vehicular bridge.
- 8: Within 120 km (75 miles) of the United States/Canada border, in the area of the Puget Sound and the Strait of Juan de Fuca and its approaches, 157.425 MHz is half of the duplex pair designated as Channel 88. In this area, Channel 88 is available to ship stations for communications with public coast stations only. More than 120 km (75 miles) from the United States/Canada border in the area of the Puget Sound and the Strait of Juan de Fuca, its approaches, the Great Lakes, and the St. Lawrence Seaway, 157.425 MHz is available for intership and commercial communications. Outside Puget Sound area and its approaches and the Great Lakes, 157.425 MHz is also available for communications between commercial fishing vessels and associated aircraft while engaged in commercial fishing activities.
- 9: When the frequency 156.850 MHz is authorized, it may be used additionally for search and rescue training exercises conducted by state or local governments.
- 10: The frequency 156.850 MHz is additionally available to coast stations on the Great Lakes for transmission of scheduled Coded Marine Weather Forecasts (MAFOR), Great Lakes Weather Broadcast (LAWEB) and nscheduled Notices to Mariners or Bulletins. F3C and J3C emissions are permitted. Coast Stations on the Great Lakes must cease weather broadcasts which cause interference to stations operating on 156.800 MHz until the interference problem is resolved.
- 11: The frequency 157.100 MHz is authorized for search and rescue training exercises by state or local government in conjunction with U.S. Coast Guard stations. Prior U.S. Coast Guard approval is required. Use must cease immediately on U.S. Coast Guard request.
- 12: The duplex pair for channel 20 (157.000/161.600 MHz) may be used for ship to coast station communications.
- 13: Available for assignment to coast stations, the use of which is in accord with an agreed program, for the broadcast of information to ship stations concerning the environmental conditions in which vessels operate, i.e., weather; sea conditions; time signals; notices to mariners; and hazards to navigation.
- 14: Available only in the Puget Sound and the Strait of Juan de Fuca.
- 15: The frequency 156.525 MHz is to be used exclusively for distress, safety and calling using digital selective calling techniques. No other uses are permitted.
- 16: The frequency 156.450 MHz is available for intership, ship and coast general purpose calling by noncommercial vessels, such as recreational boats and private coast stations.
- 17: The frequency 156.425 MHz is assigned by rule to private coast stations in Alaska for facsimile transmissions as well as voice communications.

11. WARRANTY

Marine Products Limited Warranty

PLEASE NOTE

The following "Limited Warranty" is valid for products that have been purchased in the United States and Canada. For limited Warranty details outside the United States, contact the dealer in your country.

STANDARD HORIZON (a division of VERTEX STANDARD) warrants, to the original purchaser only, each new Marine Communications Product ("Product") manufactured and/or supplied by STANDARD HORIZON against defects in materials and workmanship under normal use and service for a period of time from the date of purchase as follows:

Fixed Mount and Portable Transceivers

1 year - if purchased before 01/01/91

3 years - if purchased between 01/01/91 and 01/01/94

3 years Waterproof - if purchased after 01/01/94

Loud hailers

1 year - if purchased before 01/01/91

3 years - if purchased after 01/01/91

Associated Chargers

1 year - if purchased before 01/01/91

3 years - if purchased after 01/01/91

Associated Batteries - 18 months. Note: Batteries will be deemed defective only if storage capacity drops below 80% of rated capacity or if leakage develops.

Associated Accessories - 1 year. Includes: Microphones/Handsets, External Speakers, Antennas, Carrying Accessories, Power Supplies, and Signaling Boards.

To receive warranty service, the purchaser must deliver the Product, transportation and insurance prepaid, to STANDARD HORIZON (a division of VERTEX STANDARD). Include proof of purchase indicating model, serial number, and date of purchase. STANDARD HORIZON will return the Product to the purchaser freight prepaid. Products purchased prior to January 1, 1991 will bear the STANDARD HORIZON warranty terms in effect prior to that date.

In the event of a defect, malfunction or failure of the Product during the warranty period, STANDARD HORIZON's liability for any breach of contract or any breach of express or implied warranties in connection with the sale of Products shall be limited solely to repair or replacement, at its option, of the Product or part(s) therein which, upon examination by STANDARD HORIZON,

appear to be defective or not up to factory specifications. STANDARD HORIZON may, at its option, repair or replace parts or subassemblies with new or reconditioned parts and subassemblies. Parts thus repaired or replaced are warranted for the balance of the original applicable warranty.

STANDARD HORIZON will not warrant installation, maintenance or service of the Products. In all instances, STANDARD HORIZON's liability for damages shall not exceed the purchase price of the defective Product.

This warranty only extends to Products sold within the 50 States of the United States of America and the District of Columbia.

STANDARD HORIZON will pay all labor to repair the product and replacement parts charges incurred in providing the warranty service except where purchaser abuse or other qualifying exceptions exist. The purchaser must pay any transportation expenses incurred in returning the Product to STANDARD HORIZON for service.

This limited warranty does not extend to any Product which has been subjected to misuse, neglect, accident, incorrect wiring by anyone other than STANDARD HORIZON, improper installation, or subjected to use in violation of instructions furnished by STANDARD HORIZON, nor does this warranty extend to Products on which the serial number has been removed, defaced, or changed. STANDARD HORIZON cannot be responsible in any way for ancillary equipment not furnished by STANDARD HORIZON which is attached to or used in connection with STANDARD HORIZON's Products, or for the operation of the Product with any ancillary equipment, and all such equipment is expressly excluded from this warranty. STANDARD HORIZON disclaims liability for range, coverage, or operation of the Product and ancillary equipment as a whole under this warranty. STANDARD HORIZON reserves the right to make changes or improvements in Products, during subsequent production, without incurring the obligation to install such changes or improvements on previously manufactured Products.

The implied warranties which the law imposes on the sale of this Product are expressly LIMITED, in duration, to the time period specified above. STANDARD HORIZON shall not be liable under any circumstances for consequential damages resulting from the use and operation of this Product, or from the breach of this LIMITED WARRANTY, any implied warranties, or any contract with STANDARD HORIZON. IN CONNECTION WITH THE SALE OF ITS PRODUCTS, STANDARD HORIZON MAKES NO WARRANTIES, EXPRESS OR IMPLIED AS TO THE MERCHANTABILITY OR FITNESS FOR A PARTICULAR PURPOSE OR OTHERWISE, EXCEPT AS EXPRESSLY SET FORTH HEREIN.

Some states do not allow the exclusion or limitation of incidental or consequential damages, or limitation on how long an implied warranty lasts, so the above limitations or exclusions may not apply. This warranty gives specific legal rights, and there may be other rights which may vary from state to state.

ONLY PRODUCTS SOLD ON OR AFTER JANUARY 1, 1991 ARE COVERED UNDER THE TERMS OF THIS LIMITED WARRANTY.

ON-LINE WARRANTY REGISTRATION

THANK YOU for buying STANDARD HORIZON (a division of Vertex Standard) products! We are confident your new radio will serve your needs for many years!

Please visit www.standardhorizon.com to register the HX760S Marine VHF. It should be noted that visiting the Web site from time to time may be beneficial to you, as new products are released they will appear on the STANDARD HORIZON Web site. Also a statement regarding product support should be added to the manual.

Product Support Inquiries

If you have any questions or comments regarding the use of the HX760S, you can visit the STANDARD HORIZON Web site to send an E-mail or contact the Product Support team at (714) 827-7600 ext 6300 M-F 7:00-5:00PST.

In addition to the warranty, STANDARD HORIZON includes a lifetime "flat rate" program to provide service after the warranty period has expired. If you wish to obtain the flat rate price for out-of-warranty repair, you must include the information on the Owner's Record with the unit when you return it to your Dealer or to STANDARD HORIZON.

Lifetime Flat Rate Service Program: For the original Owner only, for the lifetime of the unit, STANDARD HORIZON will repair the unit to original specifications.

Note: The flat rate amount is payable by the Owner only if STANDARD HORIZON or the STANDARD HORIZON Dealer determines that a repair is needed. After the repair, a 90-day warranty will be in effect from the date of return of the unit to the Owner.

This service program is not available for equipment which has failed as a result of neglect, accident, breakage, misuse, improper installation or modification, or water damage (depending on the product).

12. INSTALLATION OF OPTIONS

12.1 FBA-38 ALKALINE BATTERY CASE

FBA-38 is a battery case that holds five AAA size Alkaline batteries and is used with the **HX760S** transceiver.

1. Slide the five AAA size Alkaline batteries into the **FBA-38** with the Negative (-) side of the batteries touching the spring connections inside the **FBA-38**.
2. Insert the **FBA-38** into the battery rest on the bottom of the transceiver, and then turn the Battery Pack Lock to the "LOCK" position with a coin.

NOTE

When the **FBA-38** Alkaline Battery Case is used, the **HX760S** is not able to transmit using 6 W power output.

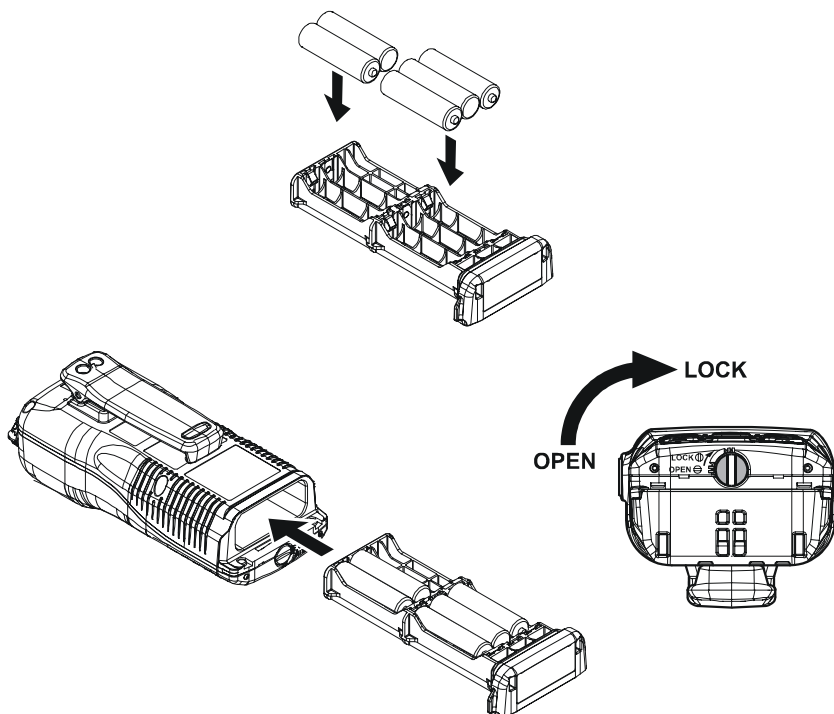

13. SPECIFICATIONS

Performance specifications are nominal, unless otherwise indicated, and are subject to change without notice.

13.1 GENERAL

Frequency Ranges:	TX: 156.025 MHz - 157.425 MHz RX: 156.050 MHz - 163.275 MHz
Channel Spacing:	25 kHz
Frequency Stability:	±10 ppm (-4 °F to +140 °F [-20 °C to +60 °C])
Emission Type:	16K0G3E
Antenna Impedance:	50 Ω
Supply Voltage:	7.4V DC, Negative Ground (Battery Terminal)
Current Consumption:	280 mA (Receive, Typical at AF MAX.) 50 mA (Standby, Bluetooth ® "Off") 100 mA (Standby, Bluetooth ® "On") 10 mA (Standby, Saver "On", Bluetooth ® "Off") 60 mA (Standby, Saver "On", Bluetooth ® "On") 1.6 A / 1.5 A / 1.0 A / 0.7 A (TX: 6 W / 5 W / 2.5W / 1W)
Operating Temperature:	-4 °F to +140 °F (-20 °C to +60 °C)
Thermometer Operating Range:	14 °F to +140 °F (-10 °C to +60 °C)
Case Size (W x H x D):	2.44" x 5.57" x 1.61" (62 x 141.5 x 41 mm) (w/o knob & antenna)
Weight (Approx.):	10.9 oz (310 g) (w/FNB-V99LI, Belt Clip, & Antenna)

13.2 TRANSMITTER

RF Power Output:	6 W / 5 W / 2.5 W / 1 W (@7.4 V)
Modulation Type:	Variable Reactance
Maximum Deviation:	±5 kHz
Spurious Emission:	-75 dBc typical
Microphone Impedance:	2 kΩ

13.3 RECEIVER

Circuit Type:	Double-Conversion Superheterodyne
Intermediate Frequencies:	1st: 47.25 MHz 2nd: 450 kHz
Adjacent Channel Selectivity:	70 dB typical
Intermodulation:	70 dB typical
Ham & Noise Ratio:	40 dB typical
Sensitivity:	0.25 μ V for 12 dB SINAD
Selectivity:	12 kHz / 25 kHz (-6 dB / -60 dB)
AF Output (Internal SP):	700 mW @16 Ω for 10 % THD (@7.4 V)

13.4 *Bluetooth*[®]

Profile:	HSP
Frequency Range:	2402 MHz - 2480 MHz
Modulation Method:	GFSK
Transmitter Output:	0 dBm Class 2
Sensitivity:	Less than -80 dBm

This device complies with part 15 of the FCC rules. Operation is subject to the condition that this device does not cause harmful interference.

Part 15.21: Changes or modifications to this device not expressly approved by Vertex Standard could void the User's authorization to operate this device.





Marine Division of VERTEX STANDARD

US Headquarters

10900 Walker Street, Cypress, CA 90630, U.S.A.

Copyright 2008
VERTEX STANDARD CO., LTD.
All rights reserved.

No portion of this manual
may be reproduced
without the permission of
VERTEX STANDARD CO., LTD.

Printed in China



E M 0 3 2 N 1 2 2