

RAY430

LOUDHAILER

INSTALLATION & OPERATION INSTRUCTIONS



PURPOSE

THIS MANUAL CONTAINS IMPORTANT INFORMATION ON THE INSTALLATION,
OPERATION AND MAINTENANCE OF YOUR EQUIPMENT

Raymarine products are supported by a network of Authorized Service Representatives. For product information, you may contact the following regional centers:

The Americas:

Raymarine, Inc.
22 Cotton Road,
Unit H, Nashua
NH 03063-4219, USA
+1 603 881 5200
+1 800 539 5539
Fax +1 603 864 4756

UK, Europe, Rest of the World:

Raymarine Ltd.
Anchorage Park
Portsmouth
Hampshire, UK
PO3 5TD
+44 23 92 693611
Fax +44 23 92 694642

For Technical Support:

+1 800 539 5539 ext. 2444

+1 603 881 5200 ext. 2444
+44 (0) 23 92 714713

Worldwide / USA - Toll-free within the
USA
Worldwide / USA
Worldwide / UK

IMPORTANT NOTICE

THIS DEVICE IS ONLY AN AID TO BOATING SAFETY AND NAVIGATION. ITS PERFORMANCE CAN BE AFFECTED BY MANY FACTORS INCLUDING EQUIPMENT FAILURE OR DEFECT, ENVIRONMENTAL CONDITIONS, AND IMPROPER HANDLING OR USE. IT IS THE USER'S RESPONSIBILITY TO EXERCISE COMMON PRUDENCE AND NAVIGATIONAL JUDGMENT. THIS DEVICE SHOULD NOT BE RELIED ON AS A SUBSTITUTE FOR SUCH PRUDENCE AND JUDGMENT.

TABLE OF CONTENTS

SECTION 1	GENERAL	
1.1	INTRODUCTION	1-1
1.2	EQUIPMENT FEATURES	1-1
1.3	SPECIFICATIONS	1-2
SECTION 2	INSTALLATION	
2.1	UNPACKING AND INSPECTION	2-1
2.2	EQUIPMENT SUPPLIED	2-1
2.2.1	Optional Accessories	2-2
2.3	STORAGE	2-2
2.4	PLANNING THE INSTALLATION	2-3
2.4.1	Mounting Options	2-5
2.5	ELECTRICAL CONNECTION	2-5
2.5.1	DC Power Connections	2-5
2.5.2	Intercom Speaker(s)	2-6
2.5.3	Hailer Horn(s)	2-7
2.5.4	Connection of Burglar Alarm	2-7
2.5.5	Remote Microphone	2-7
2.5.6	Auxiliary Input	2-8
2.5.7	Connection of an External Speaker	2-8
SECTION 3	OPERATION	
3.1	INTRODUCTION	3-1
3.2	CONTROLS AND LCD DISPLAY	3-1
3.2.1	Controls	3-1
3.2.2	LCD Display	3-3
3.3	OPERATING PROCEDURES	3-5
3.3.1	The Power Switch/Dimmer Control	3-5
3.3.2	Volume Control (Hail & Listen)	3-5
3.3.3	Hail Mode	3-6
3.3.4	Intercom Operation	3-6

3.3.5	Fog Horn Mode.	3-8
3.3.6	Aux Mode.	3-13
SECTION 4	TECHNICAL DESCRIPTION	
4.1	BLOCK DIAGRAM	4-1
SECTION 5	MAINTENANCE	
5.1	GENERAL	5-1
5.1.1	Product and Customer Service	5-1
5.2	PREVENTATIVE MAINTENANCE	5-1
5.3	ADJUSTMENT	5-2
5.3.1	Test Equipment	5-2
5.3.2	Listen Output Adjustment	5-2
5.3.3	Intercom Output Adjustment	5-3
5.3.4	Level Meter Adjustment	5-3
SECTION 6	PARTS LIST & DRAWINGS	
6.1	PARTS LIST	6-7
6.2	ASSEMBLY DRAWING	6-8
6.3	PARTS LIST FOR ASSEMBLY DRAWING	6-9
6.4	INTERNAL WIRING DIAGRAM	6-11
6.5	MAIN SCHEMATIC DIAGRAM	6-12
6.6	LINEAR A PCB PARTS LAYOUT	6-13
6.7	LINEAR B PCB PARTS LAYOUT	6-14
6.8	CPU PCB SCHEMATIC DIAGRAM	6-15
6.9	CPU PCB PARTS LAYOUT	6-16

SECTION 1

GENERAL DESCRIPTION

1.1 INTRODUCTION

Congratulations on your purchase of the RAY 430 Multifunction Loudhailer.

The RAY 430 Loudhailer is a multipurpose device that may be used as a ship-to-shore hailer, ship-to-ship hailer, foghorn, audio amplifier, intercom, and/or alarm system.

As a loudhailer, the RAY 430 amplifies your voice up to a 30 watt level, for hailing through the hailing horn speaker, and when listening for replies, amplifies the incoming sounds to the desired listening level. If an additional (optional) horn is added to the system, the loudhailer output can be switched to either or both of the hailing horn positions by the front panel control.

To verify your ownership and warranty registration, you should take a few minutes and fill out your warranty registration card found just inside the front cover of this manual. It is very important that you take the time to fill this card out. The warranty registration card should be returned to the factory immediately after your purchase in order to receive full warranty benefits.

Section 5 in this manual provides further information on obtaining Customer Service and Product Support which is available to you as a valued customer.

1.2 EQUIPMENT FEATURES

The RAY 430 is designed and manufactured to provide ease of installation and operation with excellent reliability. Some of the important built-in features of the equipment are listed below.

The loudhailer horns(s) are used as sound dispersal points when the RAY 430 is used as a foghorn so that the full 30 watt output of the unit can be employed.

In the foghorn mode any of six programmed foghorn patterns can be automatically generated. They are: Underway, Stopped, Sail, Tow, Anchored, and Aground.

INTERCOM — Provides 2-way communication between the display unit and up to 4 connected remote units, which can also originate a call to the display unit.

AUXILIARY MODE — Allows the selective or simultaneous transmission of an external audio input to all stations. For entertainment, the external audio can be a cassette deck, radio, or CD player. For business, it can also be any other instrument having an external audio output, such as the output from a VHF or SSB radiotelephone.

EXTERNAL ALARM CONNECTION — For external systems or security alarm sensors.

EASY TO USE — An ideal arrangement, the RAY 430 has an illuminated keyboard and LCD which clearly shows all selected stations and operating modes.

DURABLE, WATERPROOF CONSTRUCTION — With rugged gaskets and our heavy-duty microphone the RAY 430 is built to survive in the toughest marine environments.

SILICONE RUBBER KEYBOARD — Has backlighting for easy night-time viewing and operation.

OPTIONAL FLUSH-MOUNT KIT — For attractive customized mounting into overhead instrument cabinets or in the console of your bridge.

1.3 SPECIFICATIONS

Dimensions:	4 3/4 x 9 3/16 x 4 1/2 inches (121 x 234 x 114 mm) Height x Width x Depth
Weight	Approximately 1.9 Kg (4.3 lbs)
Power supply	13.6 VDC nominal ($\pm 20\%$) 5 amps or less
Audio Output	Hail Speaker 30W Intercom Speaker 4.5W Ext. Speaker 4.5W Int. Speaker 2.5W
Output impedances	Hail Speaker 8 ohms Intercom Speaker 8 ohms Ext. Speaker 8 ohms
Input Impedance	Mic. Impedance 600 ohms Aux Impedance 10K ohms
Input Sensitivity	Mic. Sensitivity -40 dB 3dB (at 1KHz) Aux Sensitivity -10 dB 3dB (at 1KHz) SP/Mic Sensitivity 6mV RMS $\pm 20\%$
Frequency Response	Hail Mode 100Hz to 8KHz 5dB Listen Mode 100Hz to 8KHz 5dB Aux Mode 100Hz to 20KHz 5dB
Distortion Factor	Hail Mode 10% or less (at 1KHz 30W) Listen Mode 10% or less (at 1KHz SW) Aux Mode 10% or less (at 1KHz 30W)
Signal to Noise Ratio	Hail Mode 60dB or more (at 1KHz) Listen Mode 60dB or more (at 1KHz) Aux Mode 60dB or more (at 1KHz)
Horn Frequency	500Hz \pm 50Hz

SECTION 2

INSTALLATION

2.1 UNPACKING AND INSPECTION

Use care when unpacking your new RAY 430 from the shipping carton to prevent damage to the contents. It is also a good practice to save the carton and the interior packing material. The original packing material should be used in the unlikely event that it becomes necessary in the future to return the unit for service.

2.2 EQUIPMENT SUPPLIED

The following is a list of the standard equipment included with your RAY 430 Loudhailer.

Equipment Name	Part No.
RAY 430 Loudhailer Unit	M95997
Hailer Horn	M95435
Microphone	0263596-2
Microphone Mounting Bracket	0263596-3
Mounting Yoke	0263596-4
Bridge Card	G263647-4
Instruction Manual	G263647-5

2.2.1 Optional Accessories

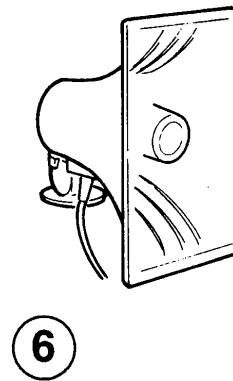
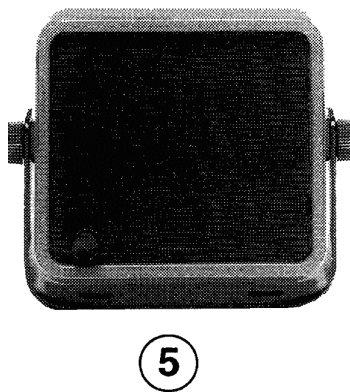
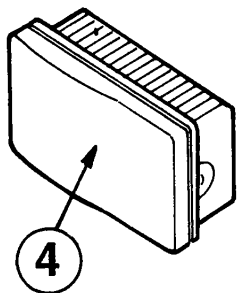
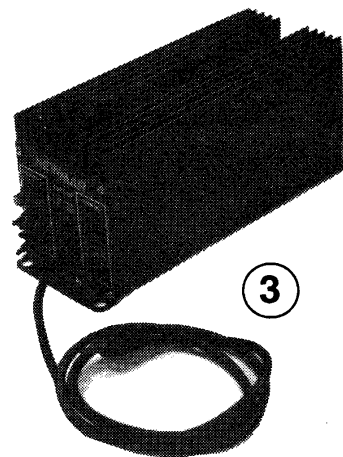
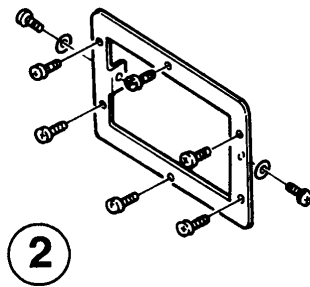
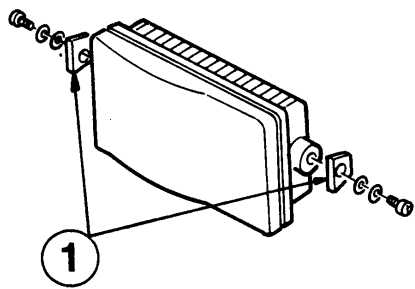

Item #	Description	Part No.
1	Console Mounting Kit (Flush Mount)	M95990
2	Console Mounting Kit (Trim Ring Style)	M95995
3	Power Supply, 115/220 VAC to 1 2 VDC	M59733
4	Sun Cover	G263696- 1
5	Intercom Speaker	M95998
6	Hailer Horn	M95435

2.3 STORAGE

After all of the components have been unpacked and inspected, they should be replaced in their shipping containers and stored in a dry place until they are to be installed. The storage area should be dry, well-ventilated and not subjected to temperature extremes below -20°C or above $+55^{\circ}\text{C}$.

2.4 PLANNING THE INSTALLATION

When planning the location for your RAY 430 to be installed, the following conditions should be considered to insure dependable and trouble-free operation.

- 1) The mounting location should be easily accessible to allow easy operation of the front panel and provide the best viewing angle of the display.
- 2) There should be adequate ventilation.
- 3) A sufficient space should be secured behind the unit to allow all cable connections to the rear panel terminal strip.
- 4) The mounting place should be located as near to the power source as possible.
- 5) The selected location should be isolated away from devices that may cause offending noise or interference, such as motors, steering cables and generators.
- 6) Generally speaking, the Loudhailer should be protected from prolonged direct exposure to rain and salt spray. It is a good practice to protect this valuable equipment as much as possible.

The unit can be conveniently mounted on a chart table, bulkhead, overhead or any other desired place. (Refer to Figure 2- 1 for typical locations and mounting configurations)

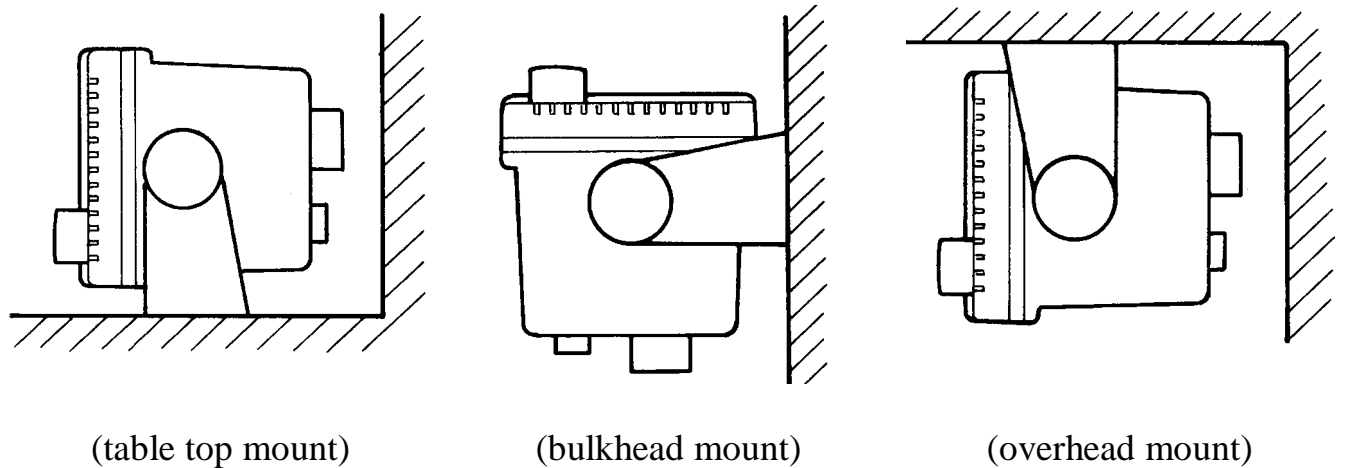

Figure 2-1 Examples of installation

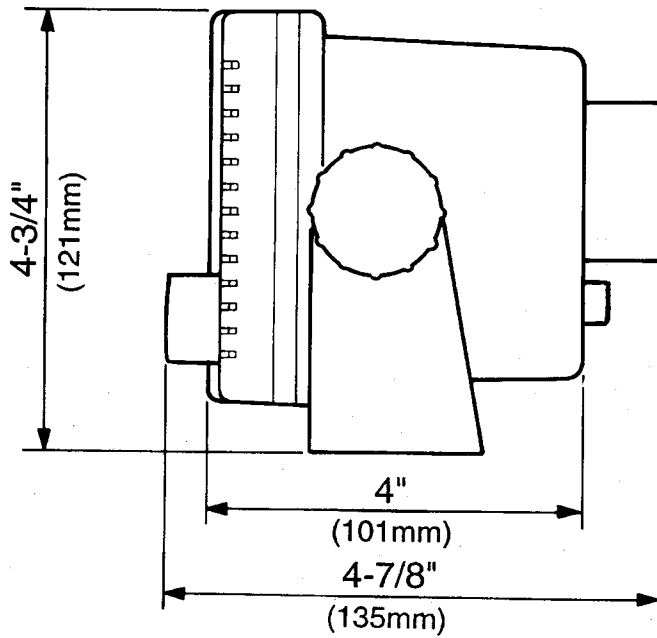
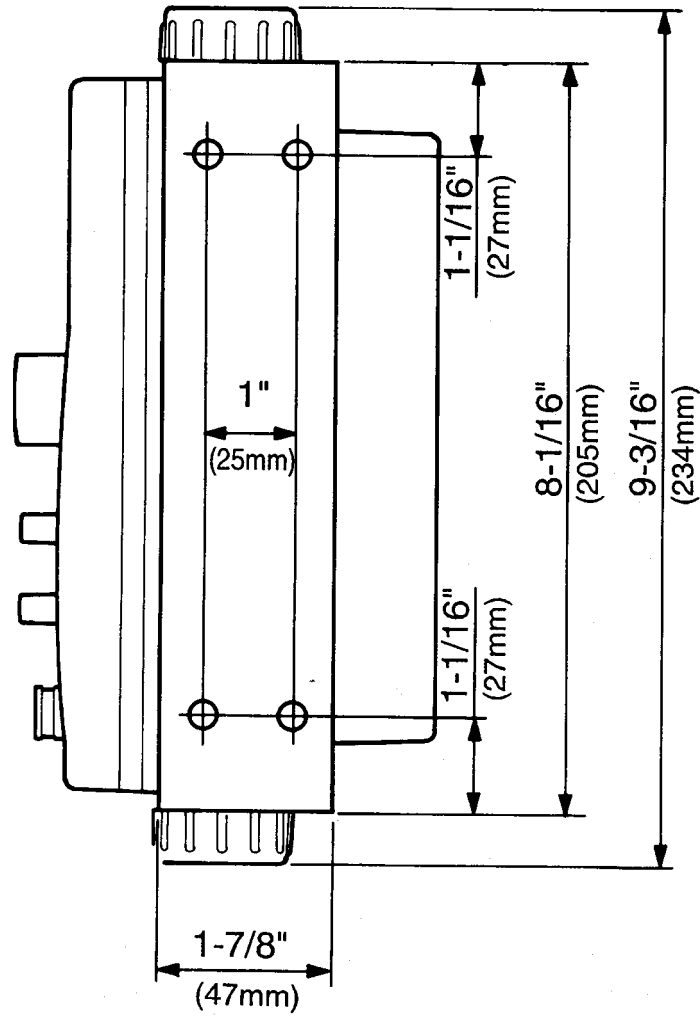

Figure 2-2 Outline and Mounting Dimensions

2.4.1 Mounting Options

Flush-mounting your RAY430 can be performed using one of the methods shown below.

Console Mounting Kit (Trim Ring Style-M95995) Console Mounting Kit (M95990)

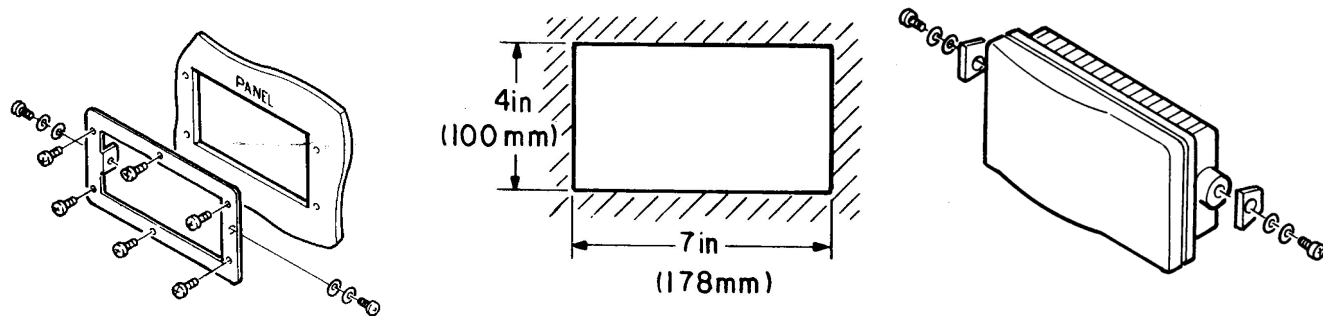

Figure 2-3

2.5 ELECTRICAL CONNECTION

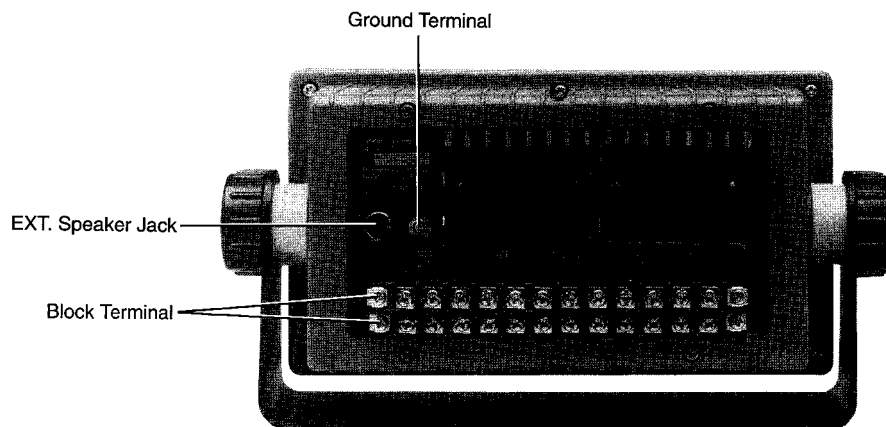

Figure 2-4 RAY430 Rear Panel

CAUTION

DO NOT INSTALL THIS RADIO ON VESSELS WITH POSITIVE
GROUND BATTERY SYSTEMS.

2.5.1 DC Power Connections

The RAY 430 is intended for use on vessels with 12 VDC power systems and can operate as long as the DC supply is regulated between 10.8 and 16 VDC.

The input power connections are made at the terminal strip on the rear of the RAY 430 unit at the terminals labeled “13.6V” “+” and “-”. See Figure 2-8 on page 2-9 for the exact locations.

The power leads should normally be routed to the ship's DC power distribution panel on larger boats. The RAY430 is fused at 10 amps so connection to a 10 amp or (maximum of) 15 amp circuit breaker is recommended. On smaller vessels the power leads may be connected directly to the main battery, isolation switch, or circuit breaker. For best noise isolation from other shipboard electronics avoid grouping the loudhailer power connections with radar, radio, or echo sounder power leads together on the same circuit breaker.

Although the RAY 430's power consumption is only 65 watts (maximum), if you find that the power cable leads need to be extended more than 10 feet, the wire size of the leads should be increased accordingly to minimize line losses. For runs of 20-35 feet #12 AWG is recommended, remember to always solder all connections on all your power cord additions.

Observe proper polarity! The wire connected to the positive (+) terminal must be connected to the positive point of the DC power source; The wire connected to the Negative (—) terminal of the terminal strip must be connected to the negative point of the DC power source. If the power leads are accidentally reversed, the 10 Amp fuse will blow. If this happens, recheck the polarity of the connections with a voltmeter (VOM) and, if necessary, reverse the leads for proper connection. Then replace the 10 amp fuse in the power cord.

2.5.2 Intercom Speaker

Up to four intercom station speakers (optional) can be connected to the intercom speaker terminals labeled IC1-IC4 on the terminal block. The optional intercom speakers M95998 are 8 ohms and include "CALL" buttons. Stations 1, 2, 3 and 4, should be connected to the terminal block accordingly so that they will correspond to the desired Intercom station selections.

Connect one of the speaker lines to terminal 2, the other line to the GND terminal (on the right side of the terminal block). The "call" line should be connected to the terminal 1.

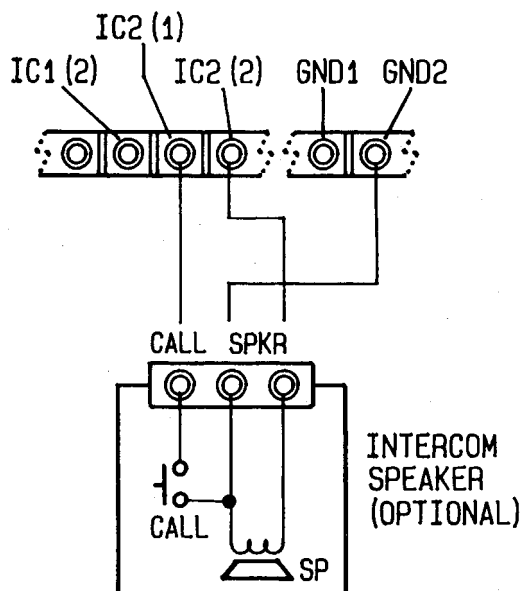

Figure 2-5

2.5.3 Hailer Horn(s)

The outside hailer horns should be mounted facing away from the display unit to prevent feedback problems using the universal swivel mount provided. High gain audio amplifier circuits “hailers” are susceptible to high frequency audio oscillations (a.k.a. feedback). It is highly recommended that before permanently mounting the hailing horn, that the HAIL feature is tested with the horn in the desired location. This should be done to ensure optimum performance. Generally speaking the horn should be mounted as far away as possible and facing away from the RAY 430 base unit. It should be pointed in the opposite direction of the RAY 430 microphone as you are speaking into it.

Connection to the horn(s) should be made with No. 18 or larger, stranded, twisted pair copper wire. The two-conductor cable chosen should be suitable for external all-weather use.

Electrical connections from the deck horn(s) are made on the rear panel terminal strip at either the FWD or AFT terminal point, depending on the location of the speaker you are connecting.

For connection to FWD, connect the deck horn to terminals “FWD” 1 and 2. For connection to AFT, connect the deck horn to terminals “AFT” 1 and 2.

2.5.4 Connection of Burglar Alarm

By connecting an external alarm sensor using a normally open type of switch (not supplied) to the ALM terminals, this unit can be used as a burglar alarm in the Fog ALM mode (burglar alarm).

When the sensor connected at terminals 1 and 2 (AUX) of this terminal block become shorted (closed), the alarm function becomes activated and the yelp signal will sound at the maximum volume through the forward deck hailer horn speaker.

Figure 2-6

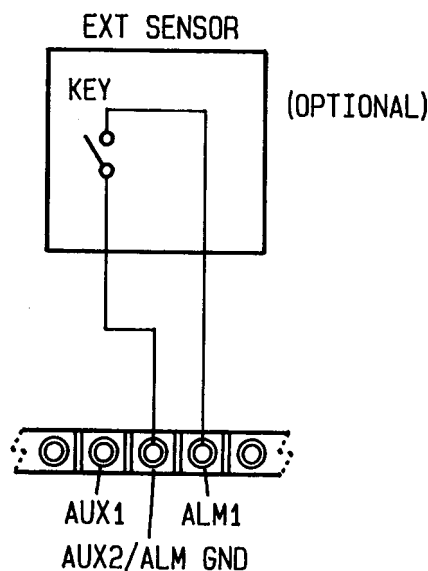

2.5.5 Remote Microphone

An external microphone connection is located on the rear panel terminal strip. This may be used if you desire to operate hailing functions from a secondary station.

Figure 2-7

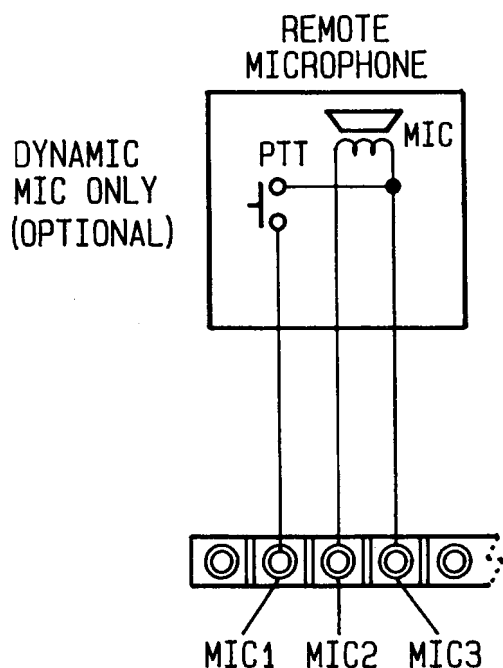

2.5.6 Auxiliary Input

Your RAY 430 has been designed to allow you to amplify the audio from your VHF radiotelephone or any other external audio output (i.e. AM/FM radio, CD player) through your intercom or deck speaker stations. This external audio input can be connected at the auxiliary input terminals 1 and 2.

2.5.7 Connection of an External Speaker

In situations where the main unit is distant from the operator and the noise level is very high, it may be difficult to hear your RAY 430 clearly. By connecting an external (8 ohms, 5 watts or more) speaker, the sound level can be increased for improved listening capability. When an external speaker is connected at the external speaker jack, the internal speaker is automatically disconnected. The connector, a mini phone plug, for the external speaker is supplied with your RAY 430 for your convenience.

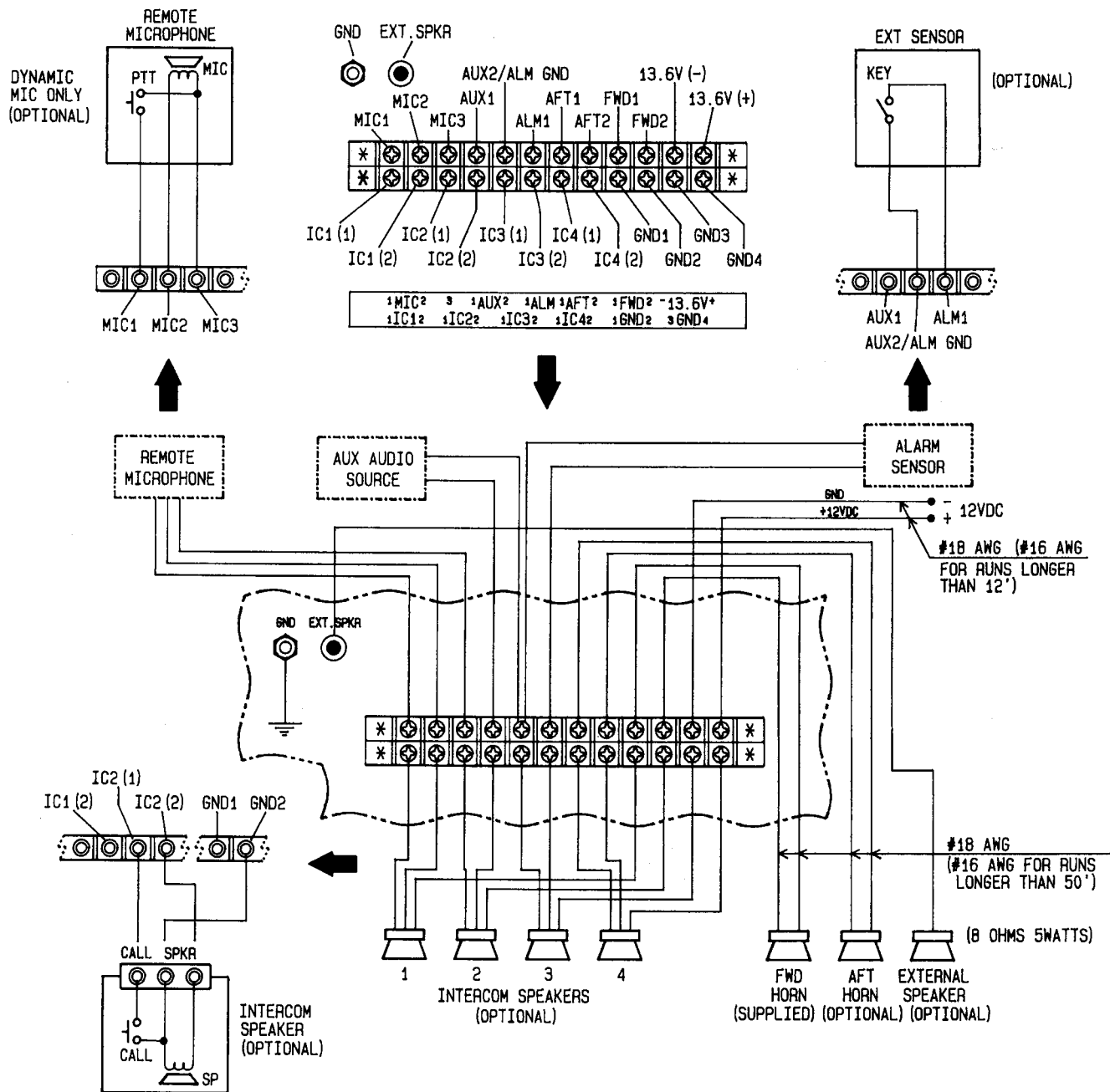

Figure 2-8 RAY430 Electrical Connections

SECTION 3

OPERATION

3.1 INTRODUCTION

While the operation of the RAY 430 is easy and straight forward, the operator who is familiar with the functions and understands the layout of the front panel controls will be able to obtain the best performance from their equipment.

Following is a description of the front panel controls of the RAY 430 loudhailer.

3.2 CONTROLS AND LCD DISPLAY

Refer to Figure 3-1 for familiarization with the following controls:

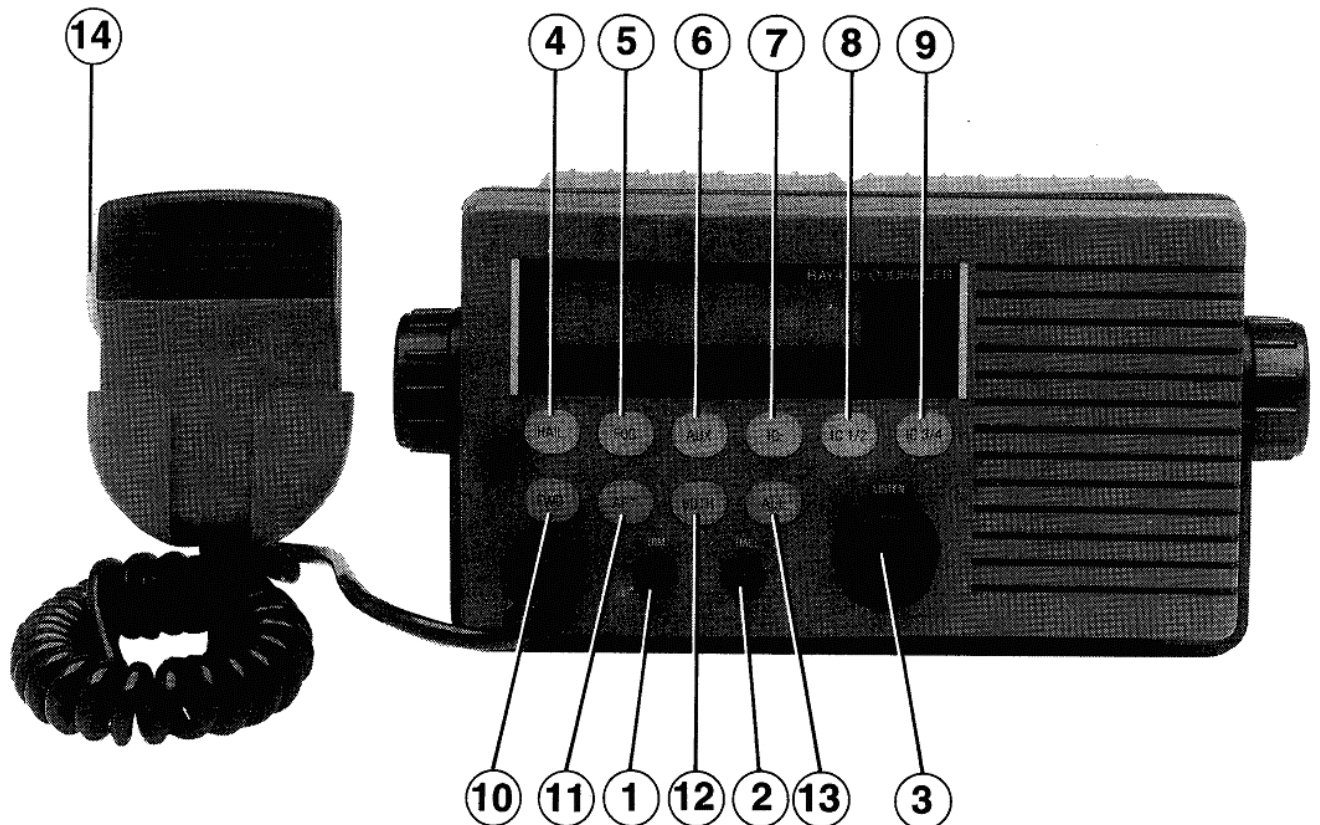

Figure 3-1 RAY430 Front Panel

3.2.1 Controls

1) On/Off & Dimmer Control Knob:

This control turns the RAY 430 On and Off, and rotating the control clockwise increases the backlighting level of the LCD display.

2) Hail Output Control:

Rotating this control clockwise will increase the volume going to the Hailer Horns or Inter-com Speaker(s) and rotating this control counterclockwise will decrease the volume.

3) Listen Control:

Rotating this control clockwise will increase the listening volume at the internal speaker and rotating this control counterclockwise will decrease the volume.

4) Hail Key:

Pressing the [HAIL] key puts the RAY 430 into the hailer mode and HAILER is displayed on the LCD.

5) FOG (Foghorn) Key:

Pressing the [FOG] key sequentially selects one of the 9 different horn or automatic fog signals for use.

6) AUX (Auxiliary) Key:

Audio signals connected to the AUX input from radiotelephone, tape player, etc. are amplified and heard at the selected external speaker location(s).

7) IC (Intercom) Key:

Pressing this key puts the RAY 430 into the Intercom mode.

8) IC 1/2 Key:

Selects between Intercom Station 1 or 2 for connection to the input/output circuitry in the Intercom Mode. Pressing the [IC 1/2] key, selects IC- 1 , IC-2, in sequence, alternately.

9) IC 3/4 Key:

Selects between Intercom Station 3 or 4 for connection to the input/output circuitry in the Intercom Mode. Pressing the [IC 3/4] key selects IC-3, IC-4, in sequence, alternately.

10) FWD (Forward) Key:

Selects the Hailer horn which is normally mounted on the forward part of the vessel for use as a foghorn, hailer or public address system.

11) AFT (After) Key:

Selects the Hailer horn which is normally mounted at the rear of the vessel for use as a fog-horn, hailer or public address system.

12) BOTH Key:

Selects both Hailer horns which are mounted on the forward and rear part of the vessel for simultaneous use as foghorns, hailing or for public address.

13) ALL Key:

Connects the input/output circuitry to all speaker stations for use simultaneously during fog-horn, hailer or public address operations.

14) Microphone PTT (Push-To-Talk) Switch

The PTT switch located on the side of the RAY 430 microphone is used to activate the microphone, etc.

3.2.2 LCD Display

The custom LCD display on the RAY 430 is used to show the operation status of the loudhailer in bright bold characters. The display is illuminated in a blue-green color with adjustable intensity for best viewing in twilight or nighttime use. The lighting can also be turned off by use of the On/Off & Dimmer control knob.

The Ray 430 has 4 operating modes. The selected mode is indicated by the message on the left side of the display. The modes messages are:

HAILER — for Hailing or public address mode

INTERCOM — for Intercom operation on up to 4 different stations

SEE TABLE — for Fog horn Signal mode. The RAY 430 generates any one of 9 automatic or manual fog horn signals.

AUX — for Auxiliary audio inputs.

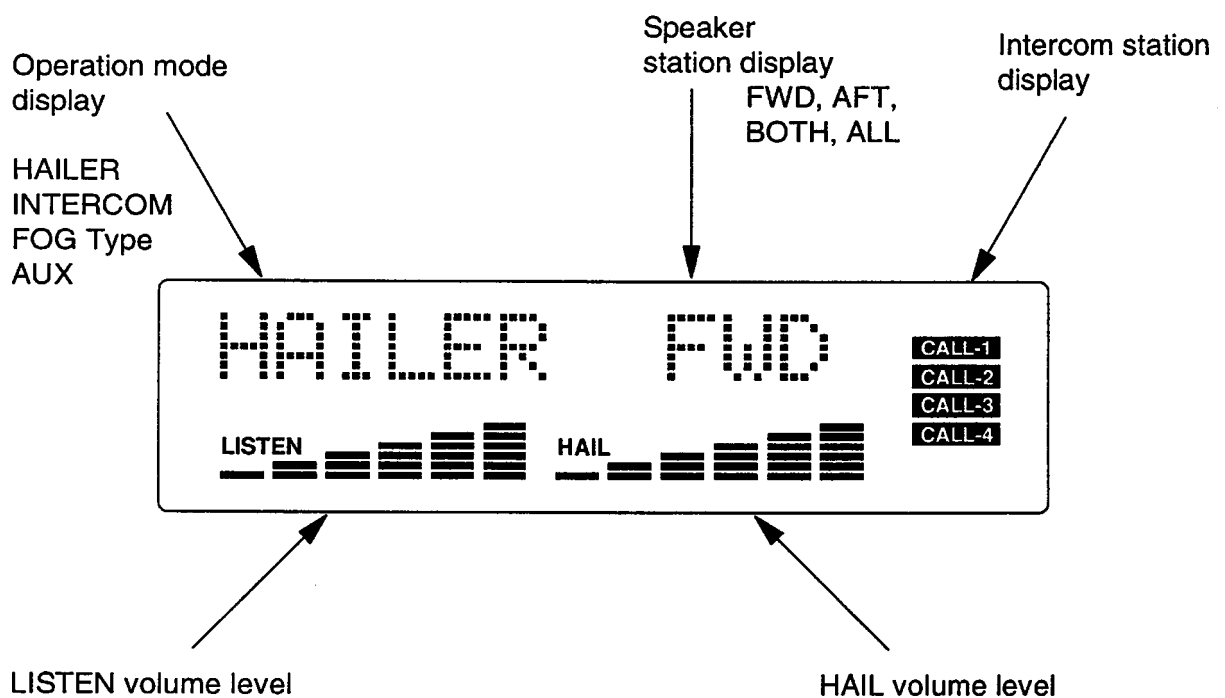

Figure 3-2 LCD Display

When the FOG mode is selected, the message area will display the selected type of signal to be emitted as follows:

	TYPE	Auto/Manual	PURPOSE
1.	MANUAL	Manual	Use as horn signal for passing, etc.
2.	UNDRWY	Automatic	Fog signal for Power Boat underway.
3.	STOP	Automatic	Fog signal for vessel that is stationary. (STOPPED)
4.	SAIL	Automatic	Fog signal for sailboat, fishboat, towboat.
5.	TOW	Automatic	Fog signal for vessels under tow.
6.	ANCHOR	Automatic	Fog signal for any vessel at anchor.
7.	AGROUND	Automatic	Fog signal for any vessel aground.
8.	YELP	Manual	Yelp type siren for police, Fish & Game, US Coast Guard.
9.	ALARM	Automatic	Burglar alarm signal when activated.

The speaker station display normally indicates the location of the speakers selected for use with each operating function. Located on the top right side of the display these messages use up to four characters. The speaker station are: FWD, AFT, BOTH, or ALL.

In the FOG mode, the speaker station message area will temporally indicate which FOG mode # has been selected for use when the [FOG] key is pushed. One second later the normal speaker station selection message will re-appear.

When the microphone push-to-talk [PTT] key is pressed in the Hail or Intercom modes, the message “TALK” appears in the speaker station window, confirming that transmission of your voice is now possible by speaking into the microphone.

Further information on the operating modes can be found in the sections that follow.

3.3 OPERATING PROCEDURES

Specific operating procedures for the RAY 430 are explained in this section. Refer to the Controls section 3.2. 1 beginning on page 3-1 for a thorough description of all RAY 430 functions.

3.3.1 The “Power Switch / Dimmer Control”

The On/Off & Dimmer control knob is used to turn on the Power, then controls backlighting levels.

TURNING THE UNIT “ON”

Rotate the On/Off & Dimmer control knob clockwise to turn the unit on. The display will appear in about 1 second. Now, set the On/Off & Dimmer Control knob to your desired backlighting level.

TO TURN THE UNIT “OFF”

Rotate the On/Off & Dimmer control knob counterclockwise to turn the unit off. The display will disappear immediately and the backlighting will be extinguished. The unit will now be OFF.

Note: You should never remove the power leads while the unit is turned on.

3.3.2 Volume Control (Hail & Listen)

1) HAIL Volume

Controls the volume level to external loudspeakers connected to the RAY430.

2) Listen Volume

This allows the user to Adjust the RAY 430 to the desired listening volume level. When the control is turned clockwise, the volume level will increase. The volume level decreases when the control is turned counterclockwise.

3.3.3 Hail Mode

The mode keys are used to select one of the four operating modes. They are HAIL, FOG, AUX or INTC.

To operate the RAY 430 as a loudhailer, proceed as follows:

1) Press the [HAIL] key.

After pressing the [HAIL] key, the HAIL mode is selected and “HAILER” appears on the LCD display in the operating mode window. In general, “Hailing” is normally performed using the forward hailing horn speaker. However, you can select the AFT horn speaker (if connected) or “Both” or “All” speakers (which includes intercoms) for general ships announcements.

2) Press the desired speaker key to select the FWD, AFT, BOTH or ALL positions as required for your particular application. Your selection appears in the speaker station window on the top right of the LCD display.

3) Press the microphone’s PTT button and speak into the microphone. Now, adjust the HAIL volume as required using the Hail knob.

In HAIL mode, upon pressing the microphone [PTT] button, “TALK” appears in the speaker window. Your voice signal is amplified through the microphone and is sent to the selected external speaker(s).

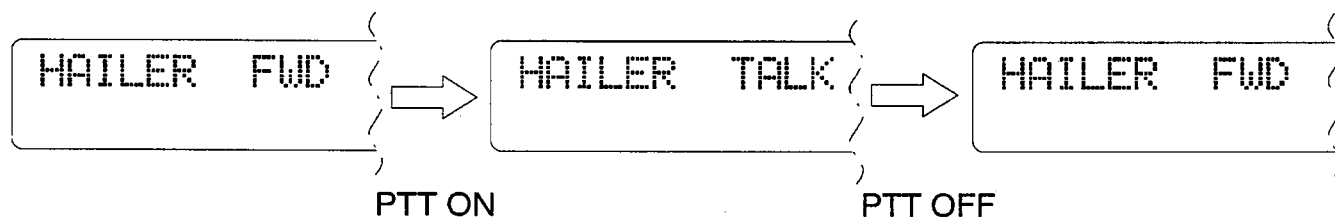

Releasing the microphone [PTT] button, “TALK” disappears from the speaker station display window and the speaker station name re-appears.

3.3.4 Intercom Operation

In general, the intercom mode is used to communicate with one of the intercom stations installed on the vessel. So if intercom operation is desired, you must first:

1. Press the [IC] key. “INTRCOM” will appear on the LCD display in the operating mode window.
2. Set the STATION ([IC 1/2], [IC3/4]) key to the desired intercom station.

Selection of the desired intercom station by pressing the appropriate station key is the

second step in operating the intercom mode. Once the station has been selected, communications from the master station (RAY 430 unit) can be enabled.

In the intercom mode, upon pressing the microphone [PTT] button, “TALK” appears in the speaker station display window. Your voice signal through the microphone is amplified and sent to the Selected intercom speaker(s).

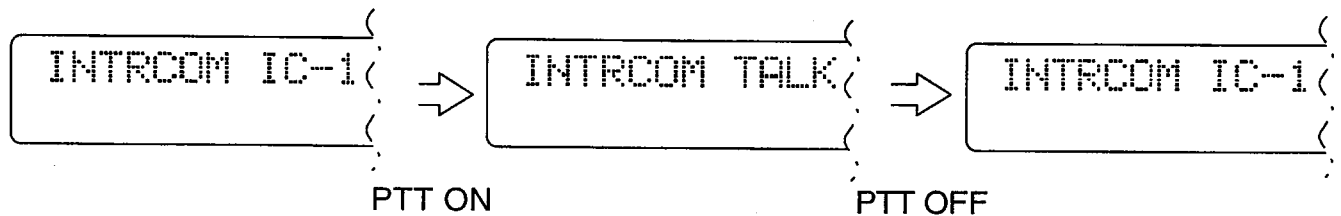

When the [PTT] button is released, the speaker at the selected station location can act as a microphone, with sounds being heard at the RAY 430 internal speaker or external speaker (if connected). The RAY 430 microphone takes priority over any responses from intercom sub-stations. This means that the sub-stations cannot be heard if the [PTT] key is held down.

Both the HAIL and LISTEN controls can be adjusted for desired volumes by rotating the Hail or Listen volume control knobs.

Marking calls from Remote Intercom Stations

As long as RAY 430 power is on, the RAY 430 master station can be called from any of the Inter-com sub-stations.

When the [CALL] switch on the sub-station speaker is pressed, both an audible beeping and an LCD display indicator tell the master station which remote station wishes to communicate with the master station. At the RAY 430 master station, the operator would then select the intercom station key corresponding to the calling station and speak into the microphone to communicate.

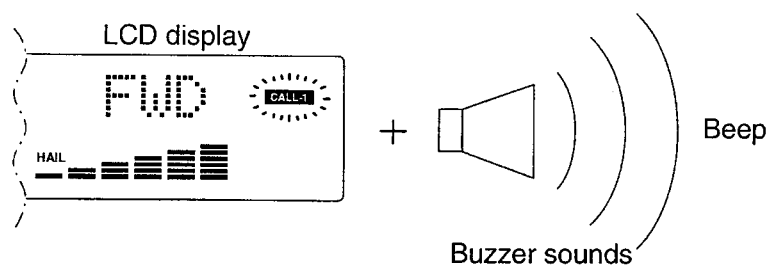

The RAY 430 allows you to connect a maximum of four intercom station speakers. The remote intercom stations cannot communicate directly with each other.

3.3.5 Fog Horn Mode

The [FOG] key allows the user to alternately select one of the automatic or manual FOG output signals. There are 9 kinds of alarms. They are: MANUAL, UNDRWY, STOP, SAIL, TOW, ANCHOR, AGROUND, YELP and ALARM. Whenever the [FOG] key is pressed, the alarm type is changed in the following order:

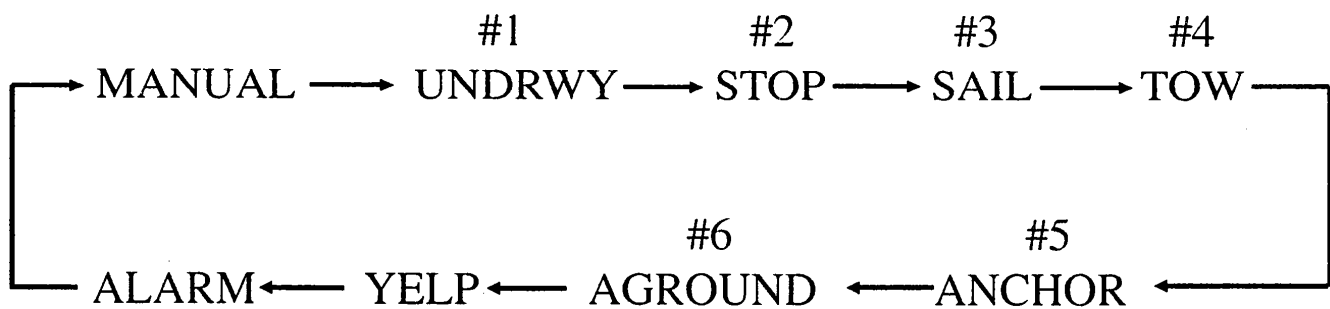

A. MANUAL — This lets the hailer serve as a horn for the vessel to permit manual horn signals as described in the ‘Rules of the Road’ - Section 35.

Usage: Passing Signals, etc.

“MANUAL” appears in the mode display window.

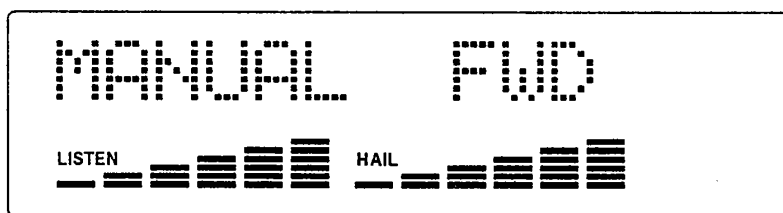

In this mode, the horn sounds when you press the microphone [PTT] button. The length and timing of the horn blasts are controlled by depressing the push-to-talk switch on the microphone.

Example:



B. UNDRWY (Fog 1) Usage: Power Boat “UNDERWAY”

This is a programmed automatic fog signal for powered vessels underway. The message “UNDRWY” appears on the mode display window. While operating the [FOG] key, “FOG 1 appears on the station display window for reference.

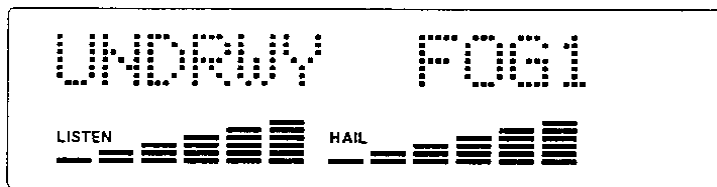

In 1 second, “FOG 1 “ disappears and the station speaker selection appears.

The Fog 1 alarm pattern is: One 5-second blast at 2 minute intervals.

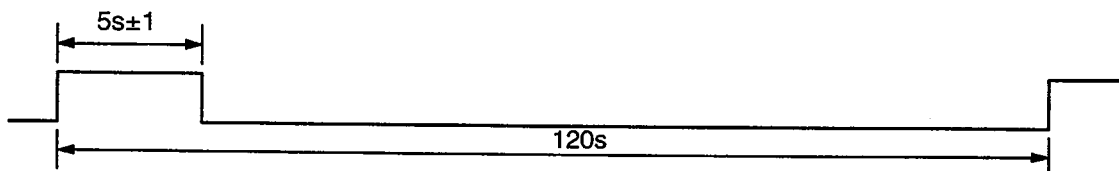

C. STOP (Fog 2) Usage: Power Boat “STOPPED”

This automatic fog signal is emitted when the vessel is stopped. The message “STOP” appears in the mode display window and “FOG 2” appears in the speaker station display window momentarily.

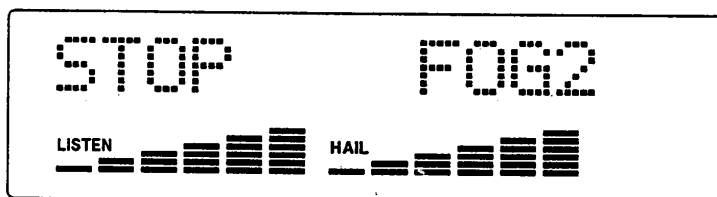

“FOG 2” disappears and the speaker station re-appears in the station display window.

The FOG 2 signal pattern is:

Two 5-second blast, with a 2 second interval between each blast, this will be repeated every 2 minutes.

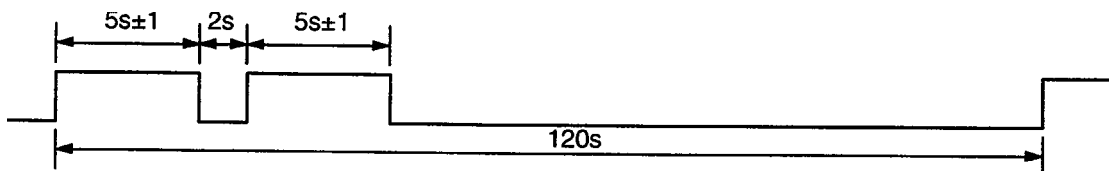

D. SAIL (FOG 3) Usage: Sail Boat, Fish Boat, Tow Boat

This automatic fog signal is used for sail boats, fish boats and tow boats underway. “SAIL” appears on the mode display part and “FOG 3” appears in the station display window when you press the [FOG] key.

“FOG 3” will disappear and the speaker station selection re-appears in the station display window.

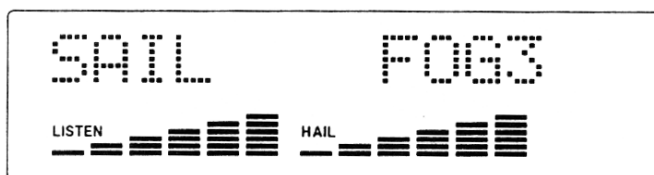

The Fog 3 signal pattern is:

One 5 second blast, followed by two 1 second blast, at 2 second intervals, this will be repeated every 2 minutes.

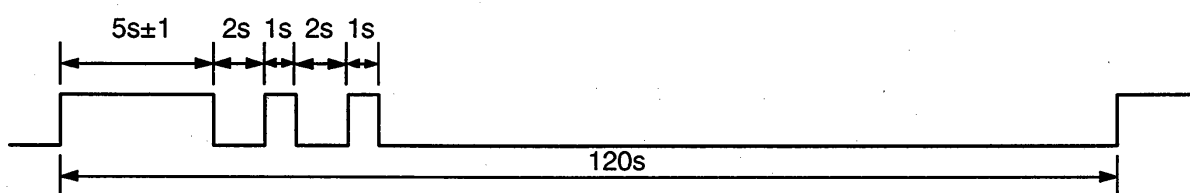

E. TOW (FOG 4) usage: Vessels Under Tow

When you press the [FOG] key again this automatic fog signal is selected, the message “TOW” appears in the mode display window and “FOG 4” is temporarily displayed in the station display window.

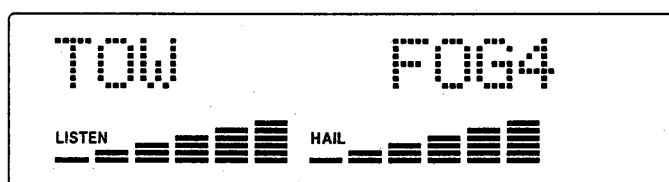

“FOG 4” will disappear and the speaker station name re-appears in the station display window after completing the FOG 4 selection.

The FOG 4 signal pattern is:

One 5 second blast, followed by three 1 second blasts, at 2 second intervals, this will be repeated every 2 minutes.

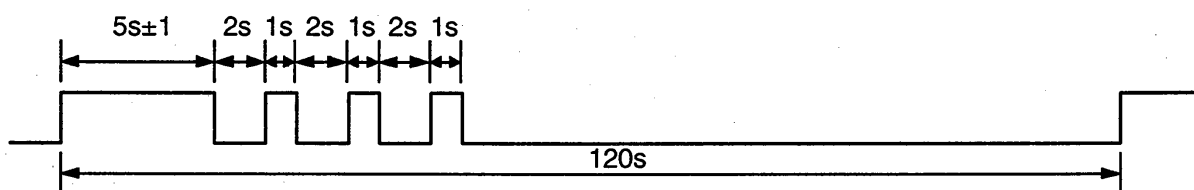

F. ANCHOR (FOG 5) Usage: Any Vessel at Anchor

For this automatic fog signal press the [FOG] key again, the message “ANCHOR” appears on the mode display and “FOG 5” appears in the station display window.

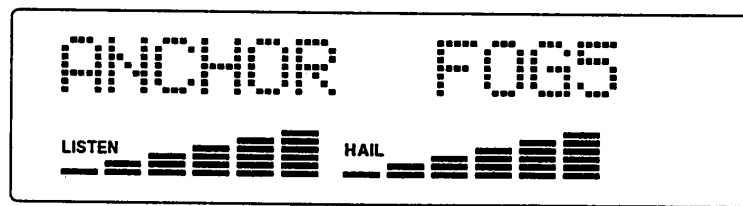

“FOG 5” will disappear and the speaker station reappears in 1 second after FOG 5 is selected.

The Fog 5 signal pattern is:

A rapidly ringing bell tone will sound for a duration of at least 5 seconds, with a repetition interval which will not exceed 1 minute.

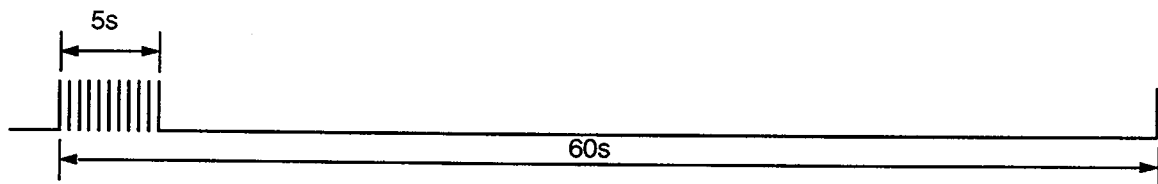

G. AGROUND (FOG 6) Usage Any Vessel Aground

When you press the [FOG] key again this automatic fog signal is selected “AGROUND” appears in the mode display window and “FOG 6” appears in the station display window.

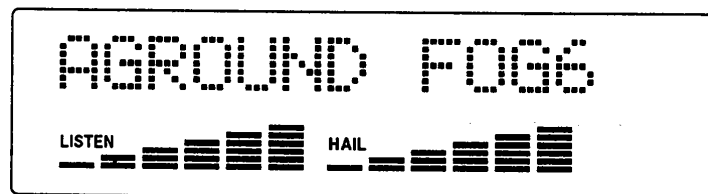

“FOG 6” will disappear and the station name reappears 1 second after completing the selection.

The Fog 6 signal is:

Three bell tones sound at one second intervals, followed by a rapidly ringing bell tone for a duration of 5 seconds, followed again by three bell tone sounds at one second intervals. This is repeated once every minute.

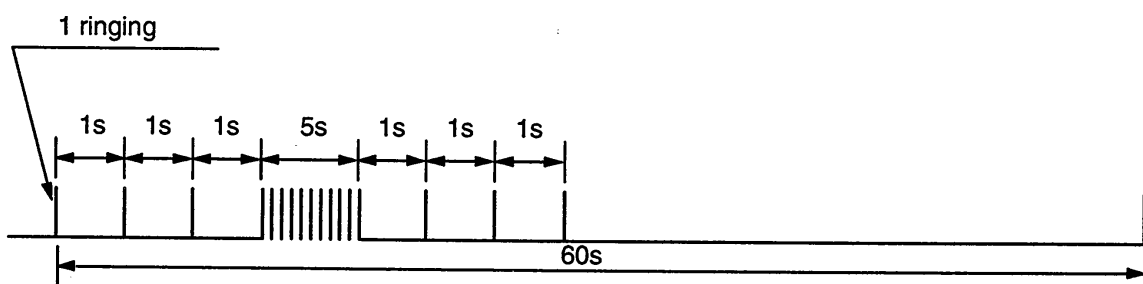

H. YELP Usage: Coast Guard, Patrol Vessels, etc.

This is a manually activated attention getting alarm signal often used by regulatory vessels. When the [FOG] key is pressed again Yelp is selected, “Yelp” appears in the mode display window.

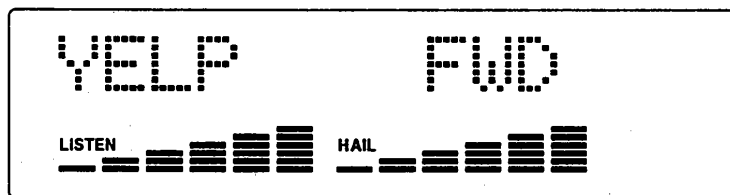

In this mode the horn yelps by pressing the microphone PTT button.

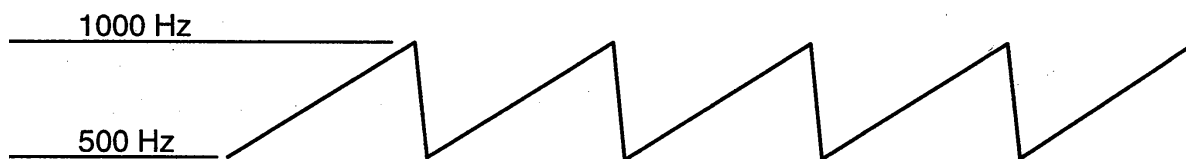

ALARM (Burglar alarm mode)

If an external normally open type switch sensor is attached (not supplied) to the ALM terminal on the rear panel, this unit can operate as a burglar alarm unit.

When the FOG mode key is pressed until “ALARM” appears on the mode display part and “BURG” appears on the station display window, the burglar alarm mode is enabled.

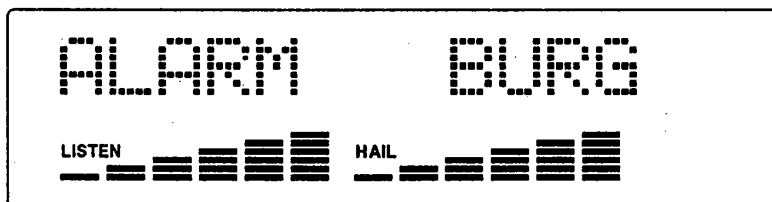

Within a few seconds “BURG” disappears and forward horn speaker station name appears. The Burglar alarm signal is a “warble” type of signal similar to the yelp signal.

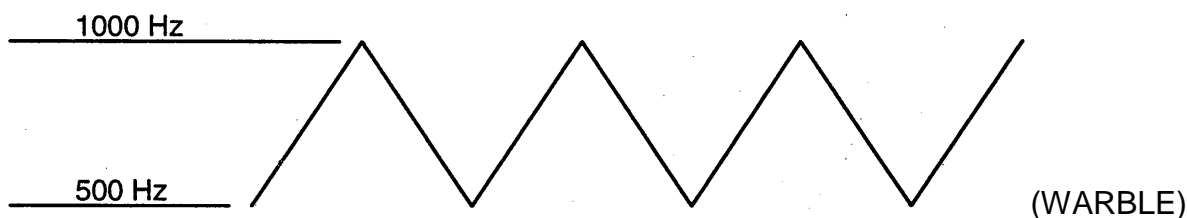

When the Burglar alarm mode is selected, the speaker station is changed to FWD, and the HAIL volume is set to the maximum level automatically.

The alarm itself is not enabled for five minutes after selection. However, in five minutes, the characters and backlighting on the LCD display window goes out and only the [FOG] key and On/Off & Dimmer Control (to Off) are operable on the RAY 430. The RAY 430 will appear to be OFE In this condition the burglar alarm will only sound if the ON signal from the external alarm sensor connected to the ALARM is tripped.

Clearing the ALARM mode

To disable the Burglar alarm mode, press the [FOG] key or turn off the RAY 430 by rotating the On/Off & Dimmer control knob fully counterclockwise.

3.3.6 Aux Mode

If the audio output line from a radiotelephone equipment, cassette deck, or entertainment receiver is connected to the AUX terminals 1 and 2, the output signals of such units can be amplified through desired speaker stations by the RAY 430.

1. Press the [AUX] mode key which will enable the auxiliary mode.
2. Press the desired speaker station key to select the specific station ([IC 1/2], [IC 3/4]).
3. Adjust the HAIL volume for the desired listening level.

SECTION 4

TECHNICAL DESCRIPTION

4.1 BLOCK DIAGRAM

Figure 4-1 is the block diagram of the RAY430. The operation of the circuitry described below is based upon this block diagram.

1. CPU

The CPU (U-203) accepts key entry from the keyboard and selects the proper input and output signals to control devices.

2. Relay

Changes input/output signals and is controlled by the CPU.

3. Relay Driver

Selects the input and output speakers

4. 5W Pre-Amp.

IC2 and IC3 amplifies low level voice signals and supplies them to the output signal selector through Listen Volume VR 1.

5. Intercom Selector

Activates the Intercom speaker with selected keyboard or Call key.

6. Output Signal Selector

Select the output signal (Foghorn Signal, Intercom, Alarm or Mic input signal) to the Power Amplifier

7. Power Amplifier

IC1 is a 30W power amplifier to active the selected speaker.

8. Interface Circuit

Senses the "CALL" or alarm sensor signals from the external unit. The photo couplers are used to reduce any external noise pickup by isolation.

9. Input Signal Selector

Selects input signal to active the FWD, AFT, INT, or EXT speaker(s).

10. Tone Generator

Generates a horn and alarm sound for the RAY 430. This generator is controlled by the CPU to produce correct sound patterns and signal timing for various automatic or manual signal outputs.

11. LCD Driver

U-202 Controls the LCD display.

12. LCD

The LCD is a custom LCD featuring 12 characters on a Dot Matrix display. The bar for the volume and the intercom call numbers are displayed with 16 segment x 8 characters.

13. EL Driver

Drives the EL, controlled by On/Off & Dimmer control knob.

14. EL

Backlights the LCD display.

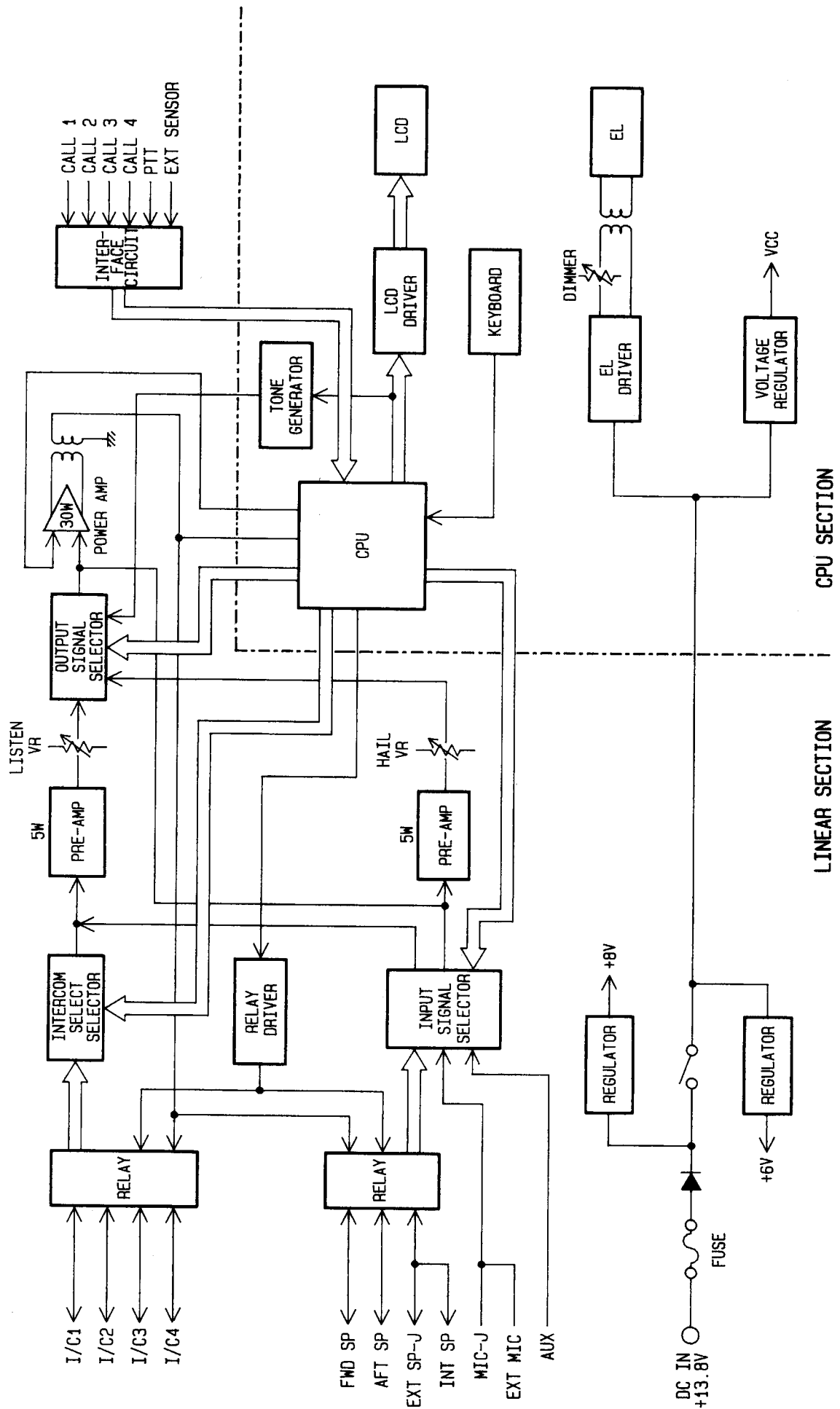

Figure 4-1 RAY430 Block Diagram

SECTION 5

MAINTENANCE

5.1 GENERAL

The purpose of this section is to provide servicing instructions to the service technician. The RAY 430 is designed to provide long periods of trouble-free operation. It is recognized, however, that environmental and other factors may result in a need for occasional service.

5.1.1 Product and Customer Service

In the event that your RAY 430 is in need of service, the dealer from whom the radio was purchased, or an authorized Raymarine dealer should be contacted for assistance. The authorized Raymarine dealer is best equipped to handle your inquiries. If, after contacting your dealer, you have further questions and require further assistance, you may contact Raymarine directly at the following numbers:

+44 23 9269 3611 (UK) or +1 800 539 5539 (US)

Phone calls to this department should deal primarily with the operations regarding: Authorized Raymarine dealer locations, basic product information, and brochure/literature requests.

Product Support: +44 23 9271 4713 (UK) or +1 800 539 5539 ext. 2444 / +1 603 881 5200 ext. 2444 (US)

Phone calls made to this department should deal primarily with the operation and technical aspects of Raymarine equipment. Please contact your dealer in advance.

When calling the above numbers, your phone call will be placed in a queue and will be answered in the order in which it was received.

5.2 PREVENTATIVE MAINTENANCE

The procedures listed below for the RAY 430 should ideally be performed at monthly intervals to minimize the possibility of an equipment failure and assure optimum performance.

1. Fuse holders and their connections may be subject to corrosion which can increase circuit resistance. The in-line fuse should be removed from its holder, inspected and cleaned of any accumulation of dirt or corrosion.

2. The unit front panel should be cleaned with a tissue or a soft non-abrasive cloth. Care should be exercised when cleaning any plastic surface to prevent scratching, especially the LCD window area. Mild soap and water may be used in stubborn cases. The unit case should be cleaned of any salt spray or dust as often as necessary.

CAUTION

Do not use solvents or other chemicals for cleaning this equipment.

5.3 ADJUSTMENT

The RAY 430 has been completely aligned at the factory and normally does not require any readjustment at installation. However, it is possible to adjust the tone level of the Hail & Intercom signal.

5.3.1 Test Equipment

1. Audio Oscillator
2. AC SSVM
3. 8-ohm Dummy Load

5.3.2 Listen Output Adjustment

Connect Audio Oscillator, AC SSVM and 8-ohm Dummy Load as shown in Figure 5-1 (Audio Oscillator output: 6 mV).

Rotate the Listen Volume fully clockwise.

Adjust VR2 for 6 V on the AC SSVM.

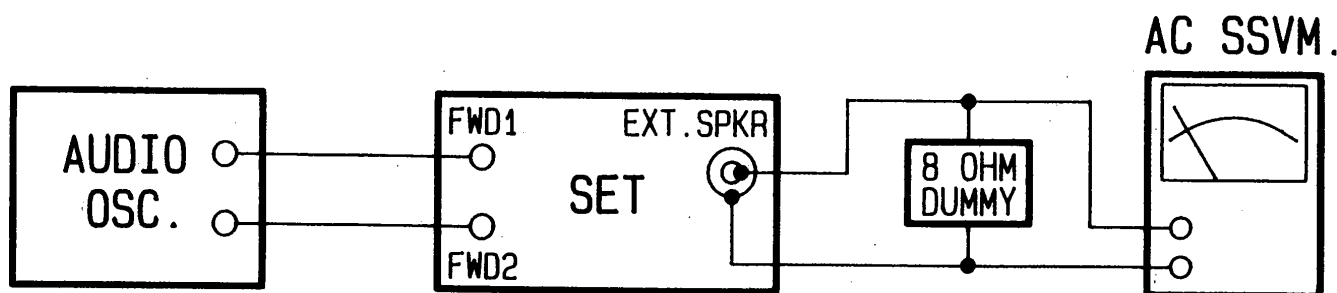

Figure 5- 1 Test connection for Listen output Adjustment

5.3.3 Intercom Output Adjustment

Connect Audio Oscillator; AC SSVM and 8-ohm Dummy Load as shown in Figure 5-2 (Audio Oscillator output: 7.5 mV).

Rotate Hail Volume fully clockwise.

Adjust VR4 for 6V on the AC SSVM.

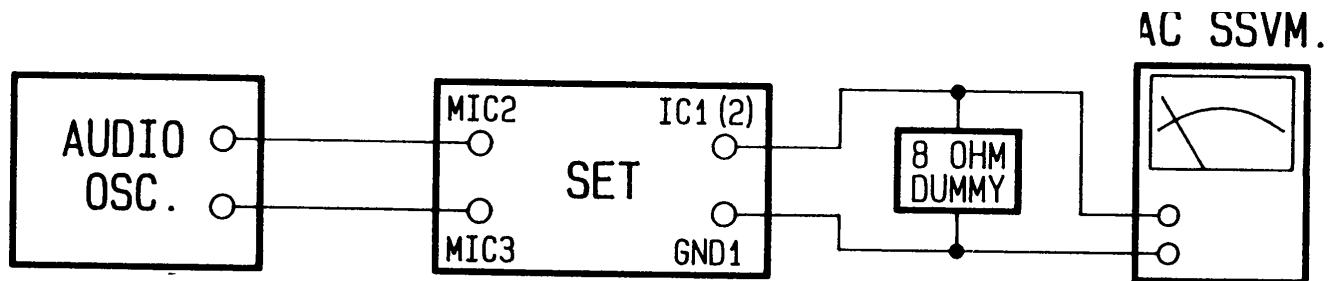

Figure 5-2 Test connection of Intercom output Adjustment

5.3.4 Level Meter Adjustment

Connect 8-ohm Dummy Load to FWD terminal.

Rotate Hail Volume fully clockwise.

Select Manual Fog operation Mode.

Press the PTT switch and adjust VZ205 to show 6 bars progressing from left to right on the LCD.

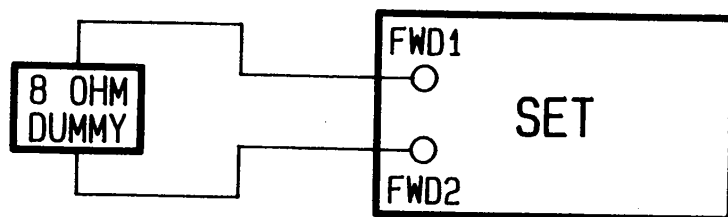

Figure 5-3 Test connection of Level Meter Adjustment

SECTION 6

6.1 PARTS LIST

***** LINEAR A PCB ASSEMBLY SECTION *****

<u>Description</u>	<u>Qty.</u>	<u>Symbol</u>	<u>Part No.</u>
Linear A PCB Assembly	1		G263648- 1
<u>Capacitors</u>			
Ceramic, 0.001 μ F	10	C10, 14, 15, 18, 35, 66, 67, 68, 69, 72	
Ceramic, 0.047 μ F	2	C30, 31	
Ceramic, 0.1 μ F	5	C29, 38,41,42, 65	
Elec., 2.2 μ F/50WV	4	C11 33, 36, 71	
Elec., 10 μ F/16WV	20	C49, 12, 13, 17, 19, 23, 25, 26, 28, 32, 34, 56, 58, 59, 60,61,70,75, 127	
Elec., 33 μ F/25WV	2	C39, 44	
Elec., 47 μ F/25WV	3	C24, 63, 64	
Elec., 1 00 μ F/10WV	4	C22, 40, 43, 57	
Elec., 220 μ F/10WV	2	C21, 62	
Elec., 470 μ F/25WV	1	C37	
<u>Resistors</u>			
Metal Glaze, 1 ohm	2	R78, 79	
Metal Glaze, 20 ohm	2	R76, 81	
Metal Glaze, 100 ohm	2	R58, 92	
Metal Glaze, 1k ohm	2	R77, 80	
Metal Glaze, 2.2k ohm	5	R22, 27, 29, 31, 34	
Metal Glaze, 3.3k ohm	2	R51, 84	
Metal Glaze, 4.7k ohm	8	R32, 33, 35, 41, 49, 60, 62, 66	
Metal Glaze, 10k ohm	9	R52, 59, 65, 67, 85, 91, 93, 98, 99	

<u>Description</u>	<u>Qty.</u>	<u>Symbol</u>	<u>Part No.</u>
<u>Resistors (cont.)</u>			
Metal Glaze, 22k ohm	4	R 19, 20, 63, 64	
Metal Glaze, 100k ohm	17	R26, 28, 30, 36, 39, 40, 43, 44, 57, 68, 69, 70, 71, 86, 94, 95, 97	
Metal Glaze, 220k ohm	12	R53, 54, 55, 56, 72, 73, 74, 75, 87, 88, 89, 90	
Metal Glaze, 270k ohm	1	R61	
<u>Semiconductors</u>			
I.C., μ PC2500	1	IC1	G263648-6
I.C., BA333	2	IC2, 3	
I.C., TC4066BF	3	IC4, 5, 6	
Diode, 1S1888A	2	D7, 8	
Diode, 1SS123	2	D10, 12	
<u>Miscellaneous</u>			
Connector, 4-173146-1	1	CN9	
Connector, 5483-02	2	CN8, 13	
Connector, 5483-03	2	CN11, 12	
Connector, 9651S-20A	1	CN10	
Semi-Fixed Resistor, 1k ohm	1	VR2	
Semi-Fixed Resistor, 5k ohm	1	VR4	

***** LINEAR B PCB ASSEMBLY SECTION*****

Linear B PCB Assembly	1		G263648-2
-----------------------	---	--	-----------

Capacitors

Ceramic, 680 pF (NP0)	1	C2	
Ceramic, 0.001 μ F	1	C74	
Ceramic, 0.01 μ F	1	C16	
Ceramic, 0. 1 μ F	4	C46, 48. 53, 54	

<u>Description</u>	<u>Qty.</u>	<u>Symbol</u>	<u>Part No.</u>
<u>Capacitors (cont.)</u>			
Elec., 10 μ F/16WV	5	C 1 , 5, 6, 7, 8	
Elec., 47 μ F/25WV	4	C47, 49, 50, 55	
Elec., 1000 μ F/25WV	1	C52	
<u>Coils</u>			
Coil, 5- 1 9-CZ99Z	1	CH1	
<u>Resistors</u>			
Metal Film, 4.7 ohm (3W)	1	R16	
Metal Glaze, 100 ohm	3	R37, 42, 45	
Metal Glaze, 1k ohm	6	R1, 3, 5, 7, 9,46	
Metal Glaze, 2.2k ohm	1	R11	
Metal Glaze, 10k ohm	8	R2, 4, 6, 8, 10, 12, 47, 48	
Metal Glaze, 22k ohm	1	R13	
<u>Semiconductors</u>			
I.C., TD62307P	1	IC9	
I.C., TLP121-4	1	IC10	
I.C., TLP121-1	2	IC11, 13	
Regulator, TA78006AP	1	IC7	
Regulator, TA78008AP	1	IC8	
Transistor, 2SA1298(O)	1	Q1	
Transistor, 2SC41 16(O)	1	Q2	
Diode, 1S1888A	7	D1, 2, 3, 4, 5, 6, 9	
Diode, 1N5401	1	D15	
<u>Miscellaneous</u>			
Relay, G6E-134P (12V DC)	5	RY1, 2, 3, 4, 7	G263648-14
Relay, G6B-2114P (12V DC)	2	RY5, 6	G263648-15
Connector, 2-173145-8	1	CN2	
Connector, 5483-02	1	CN4	
Connector. 5483-04	1	CN3	

<u>Description</u>	<u>Qty.</u>	<u>Symbol</u>	<u>Part No.</u>
<u>Miscellaneous (cont.)</u>			
Connector, 5483-05	1	CN5	
Connector, 965 1S-6A	1	CN7	
Connector 965 1S-20A	1	CN6	
<u>*****AGC PCB ASSEMBLY SECTION*****</u>			
AGC PCB Assembly	1		G263648-3
<u>Capacitors</u>			
Elec., 10~F/16WV	2	C301, 302	
<u>Resistors</u>			
Metal Glaze, 4.7k ohm	4	R302, 303, 304, 305	
Metal Glaze, 10k ohm	2	R306, 307	
Metal Glaze, 22k ohm	1	R30 1	
<u>Semiconductors</u>			
Transistor, 2SC27 (GRTE8SL)	1	2 2	Q302, 303
Transistor, RN1403	1		Q304
Transistor, RN1410	1		Q301
Diode, 1SS308	1		D301
Diode, 155193	1		D302
Diode, 1 SS 1 23	1		D303
Zener Diode, 02CZ6.2X	1		D304
<u>Miscellaneous</u>			
Connector, B5B-PH-K-S ,	1		CN301
Connector, B7B-PH-K-S	1		CN302

*****CPU PCB ASSEMBLY SECTION*****

<u>Description</u>	<u>Qty.</u>	<u>Symbol</u>	<u>Part No.</u>
CPU PCB Assembly	1		G263648-4

Capacitors

Ceramic, 10 pF (NP0)	2	C201 , 202
Ceramic, 100 pF (NP0)	20	C207, 208, 209, 210, 211, 212, 213, 214, 215, 216, 217, 218, 219, 220, 221, 222, 223, 224, 225, 245
Ceramic, 0.1 μ F	6	C203, 228, 232, 237, 238, 241
Elec., 1 μ F/16WV	2	C226, 227
Elec., 4.7 μ F/16WV	1	C236
Elec., 10 μ F/25WV	1	C244
Elec., 100 μ F/10WV	1	C205
Elec., 100 μ F/16WV	1	C231
Elec., 100 μ F/25WV	1	C206
Mylar, 0.0082 μ F	1	C229
Tant., 1 μ F/25WV	1	C230

Transformers

EL Transformer, S19-C99SPT	1	T201
----------------------------	---	------

Resistors

Metal Glaze, 0 ohm (Jumper)	1	R245
Metal Glaze, 10 ohm	1	R247
Metal Glaze, 22 ohm	1	R250
Metal Glaze, 100 ohm	7	R237, 238, 239, 240, 241, 242, 247
Metal Glaze, 150 ohm	1	R249
Metal Glaze, 220 ohm	1	R268
Metal Glaze, 1k ohm	21	R218, 219, 220, 221, 222, 223, 224, 225, 226, 227, 228, 229, 230, 231, 232,

<u>Description</u>	<u>Qty.</u>	<u>Symbol</u>	<u>Part No.</u>
<u>Resistor (cont.)</u>			
Metal Glaze, 1k ohm		R233, 234, 235, 236, 243, 255	
Metal Glaze, 2.2k ohm	16	R201, 202, 203, 204, 205, 206, 207, 208, 209, 210, 212, 213, 214, 215, 216, 259	
Metal Glaze, 6.8k ohm	1	R248	
Metal Glaze, 10k ohm	2	R264, 266	
Metal Glaze, 15k ohm	1	R265	
Metal Glaze, 47k ohm	5	R252, 260, 261, 262, 263	
Metal Glaze, 9 1 k ohm	1	R211	
Metal Glaze, 100k ohm	2	R251, 254	
<u>Semiconductors</u>			
I.C., μ PD7801 1	1	U203	
I.C., HD44780SA00FH	1	U202	
I.C., SN76489AN	1	U204	
Regulator, TA78L006AP	1	U20 1	G263597-19
Transistor, RN1410	8	Q201, 202, 203, 204, 205, 206, 209, 211	
Transistor, 2SC2712(GRTE8SL)	2	Q207, 208	G263597-9
Transistor, 2SA1 162(YTE85L)	1	Q210	
Diode, 1SS226	1	D201	
LED, TLG260	1	D204	
<u>Miscellaneous</u>			
EL-Panel, GE-92D-9949	1	EC201	G263597-24
Crystal, TCS-5 8.064MHz	1	X201	
Tant. Switch, SKQHFH (G/G)/SK3QH00001	10	SW201, 202, 203, 204, 205, 206, 207, 208, 209, 210	G263597-16
Semi-Fixed Resistor 10k ohm	1	VZ205	
Connector, 965 1S-20A	2	J201, 202	
Connector, 965 1 S-6A	1	J203	

<u>Description</u>	<u>Qty.</u>	<u>Symbol</u>	<u>Part No.</u>
<u>***** DIM/HAIL PCB ASSEMBLY SECTION *****</u>			
Dim/Hail PCB Assembly	1		G263648-5
Volume, 5k ohm (B)	1		
Volume, 10k ohm (A)	1		
<u>***** CHASSIS ASSEMBLY SECTION *****</u>			
Bezel Assembly W/LCD Window	1		G263648- 18
Knob Dim/Hail	2		G263648-25
LCD Spacer	1		
Knob Listen	1		G263648-26
Listen Control Nut Assembly	1		
Cabinet Rear	1		G2636597-27
Cabinet Cap	1		
Dim/Hail Control Nut 7m/m	2		
Key Top Reflector	10		G263597-29
LCD Interconnector	2		G263648-20
Front Gasket	1		G261 808-1
Rear Chassis	1		
Side Chassis R	1		
Side Chassis L	1		
Transformer Bracket	1		
Yoke Bracket	1		G263596-4
Yoke Knob W/Screw	2		G263806- 1
Yoke Spacer	2		G261807-1
Internal Speaker	1		G263597-13
Heat Sink Rear	2		
Gasket Rear	1		G263597-28
Terminal Block	1		G263648-21
Knob Spacer	2		
Vol. Spacer	2		
Heat Sink (IC-1)	1		
PCB Spacer	2		
LCD	1		G263648-24

6.2 ASSEMBLY DRAWING

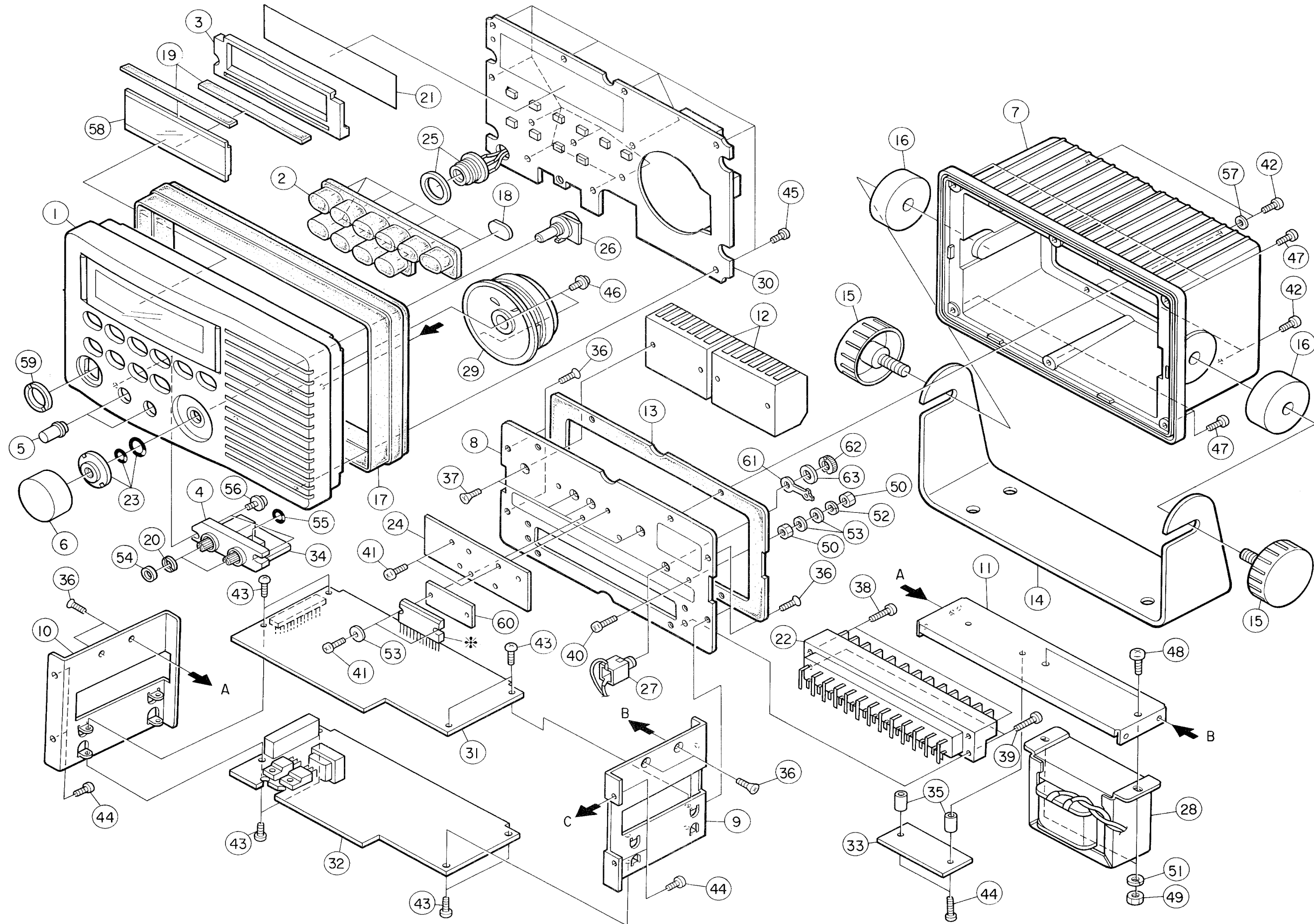

* = Not supplied with PCB Assembly.
See parts list for component part number.

6.3 PARTS LIST for ASSEMBLY DRAWING

<u>NO.</u>	<u>DESCRIPTION</u>	<u>QTY.</u>	<u>PART NO.</u>	<u>NO.</u>	<u>DESCRIPTION</u>	<u>QTY.</u>	<u>PART NO.</u>
1	BEZEL ASSEMBLY	1	G263648- 18	39	PANHEAD 3x15	2	
2	KEY TOP (WJBEZEL ASSY)	1	G263648- 19	40	PANHEAD 3x10	1	
3	LCD SPACER	1		41	PANHEAD 3x8	4	
4	LIGHT PIPE DIM/HAIL (WIBEZEL ASSY)	1		42	PANHEAD BLACK 3X8	4	
5	KNOB DIM/HAIL	2	G263597-25	43	BRAZIERHEAD TAPPING 3x8	4	
6	KNOB LISTEN	1	G263597-26	44	BRAZIERHEAD TAPPING 3x10	6	
7	CABINET REAR	1	G263597-27	45	PANHEAD P TIGHT 3x8	6	
8	REAR CHASSIS	1		46	PANHEAD P TIGHT WIFLANGE 2x4	12	
9	SIDE CHASSIS R	1		47	PANHEAD P TIGHT BLACK 3x I 0	4	
10	SIDE CHASSIS L	1		48	BINDINGHEAD 4x8	2	
11	TRANSFORMER BRACKET	1		49	NUT 4m/m	2	
12	HEAT SINK REAR	1		50	NUT 3m/rn	2	
13	GASKET REAR	1	G263597-28	51	SPRING WASHER WIFLANGE 4m/rn	2	
14	YOKE BRACKET	1	G263596-4	52	SPRING WASHER 3m/rn	1	
15	YOKE KNOB W/SCREW	2	G261806-1	53	PLAIN WASHER 3m/rn	4	
16	YOKE SPACER	2	G261807- 1	54	KNOB SPACER	2	
17	GASKET FRONT	1	G261808-1	55	SPACER	2	
18	KEY TOP REFLECTOR	10	G263597-29	56	PANHEAD P TIGHT WIFLANGE 3x6	2	
19	LCD INTERCONNECTOR	2	G263648-20	57	NYLON WASHER 6x3x0.5	4	
20	NUT DIM/HAIL CONTROL	2		58	LCD DISPLAY	1	G263648-24
21	EL-PANE (W/CPUPCB ASSY)	1	G263597-24	59	MIC JACK NUT	1	
22	TERMINAL BLOCK	1	G263648-2 1	60	INSULATOR	1	
23	CHANNEL NUT ASSEMBLY	1		61	CAP (SPEAKER JACK)	1	
24	HEATSINK (IC-1)	1		62	NUT (SPEAKER JACK)	1	
25	MIC JACK (W/BEZEL ASSY)	1	G263 129-58	63	WASHER (SPEAKER JACK)	1	
26	LISTEN CONTROL	1	G263648-22				
27	EXT SPJACK	1	G263014-26				
28	TRANSFORMER	1	G263648-23				
29	INTERNAL SPEAKER (8 OHM 3 W)	1	G263597- 1 3				
30	CPU PCB ASSEMBLY	1	G263648-4				
31	LINEAR A PCB ASSEMBLY	1	G263648- 1				
32	LINEAR B PCB ASSEMBLY	1	G263648-2				
33	AGC PCB ASSEMBLY	1	G263648-3				
34	DIM/HAIL PCB ASSEMBLY	1	G263648-5				
35	AGC PCB SPACER	1					
36	COUNTERSUNKHEAD TAPPING 3X8	4					
37	COUNTERSUNKHEAD 3X8	4					
38	PANHEAD	2					

6.4 INTERNAL WIRING DIAGRAM

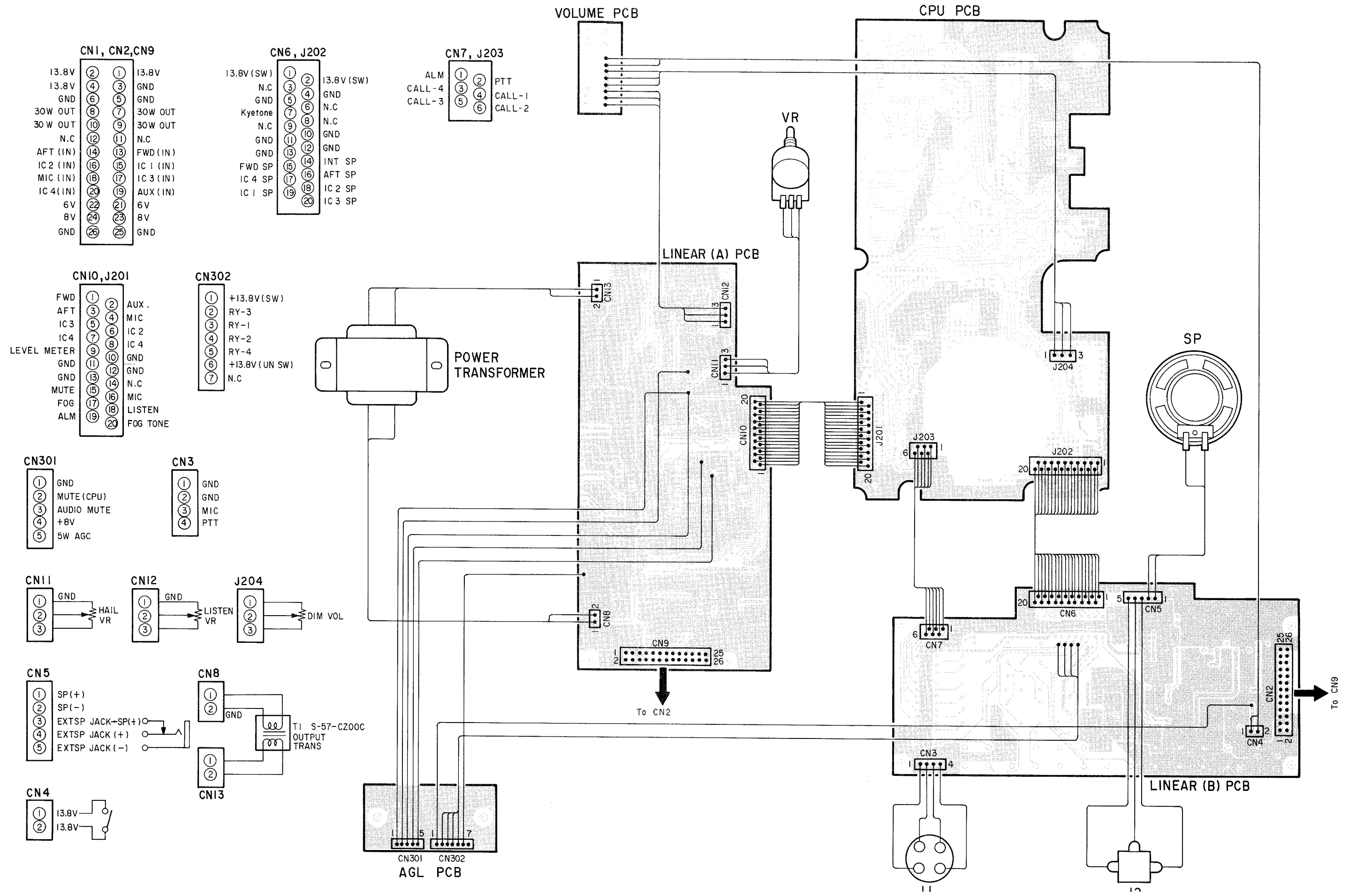

Figure 6-2
Block Diagram

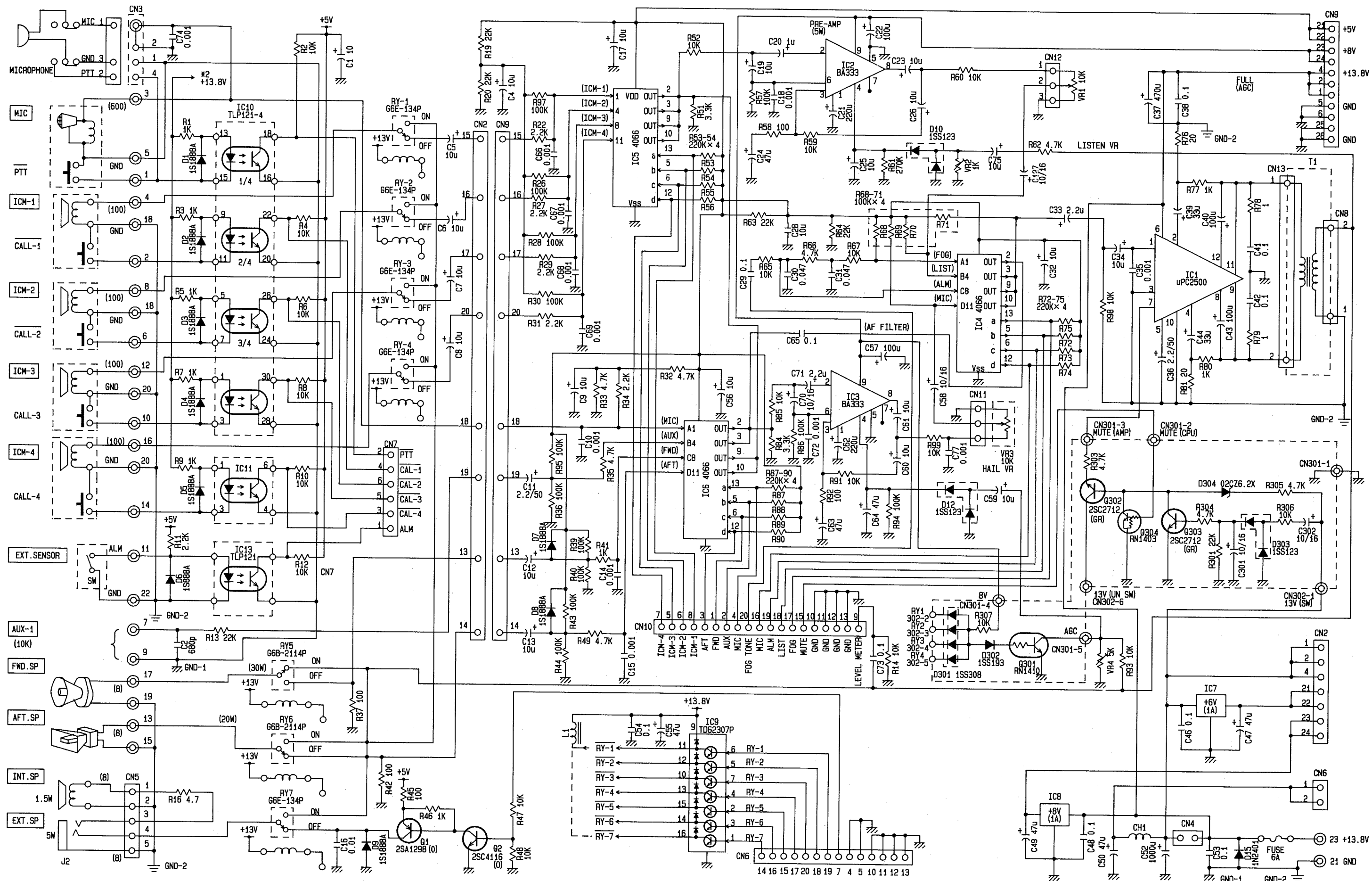
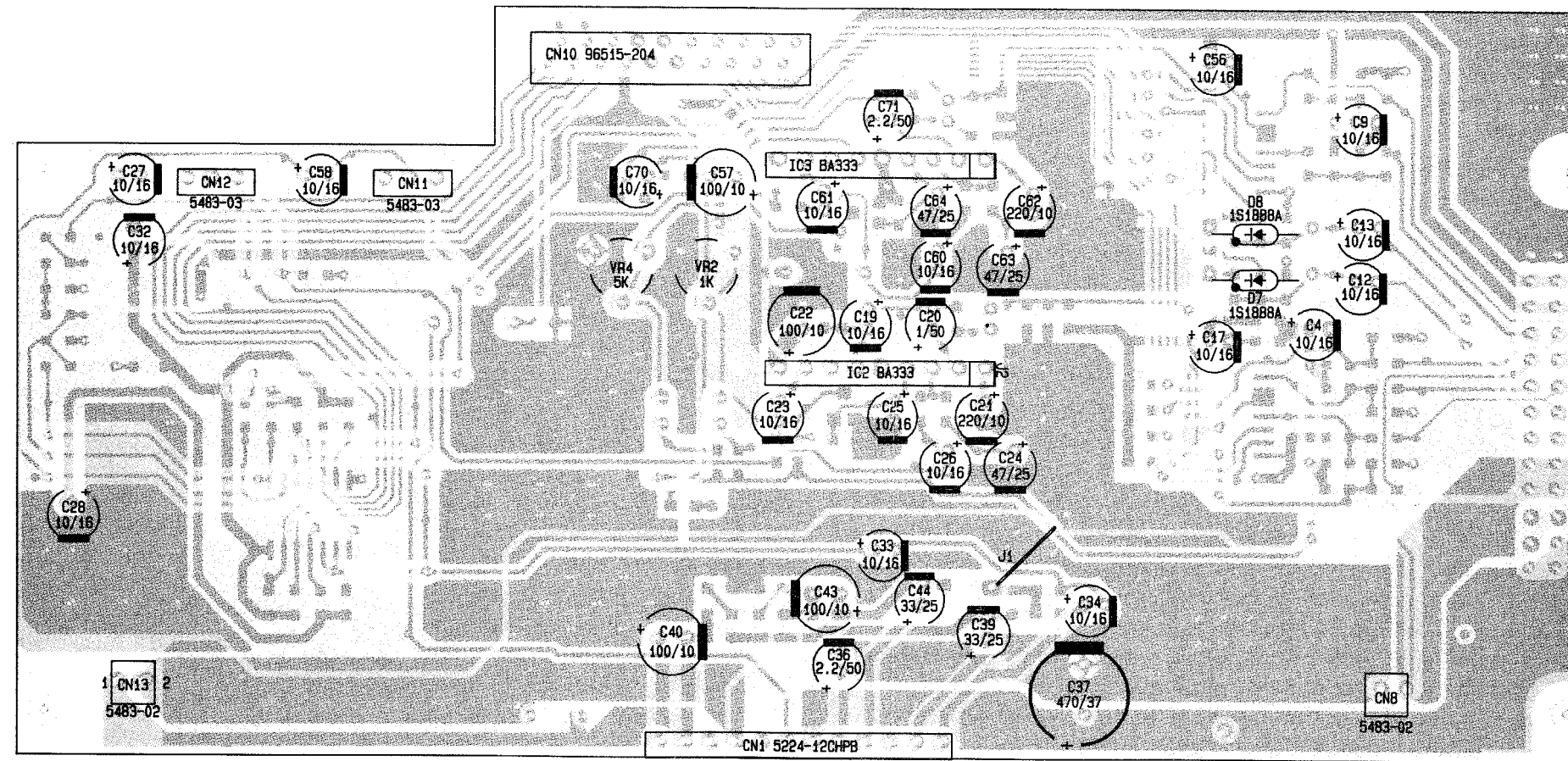
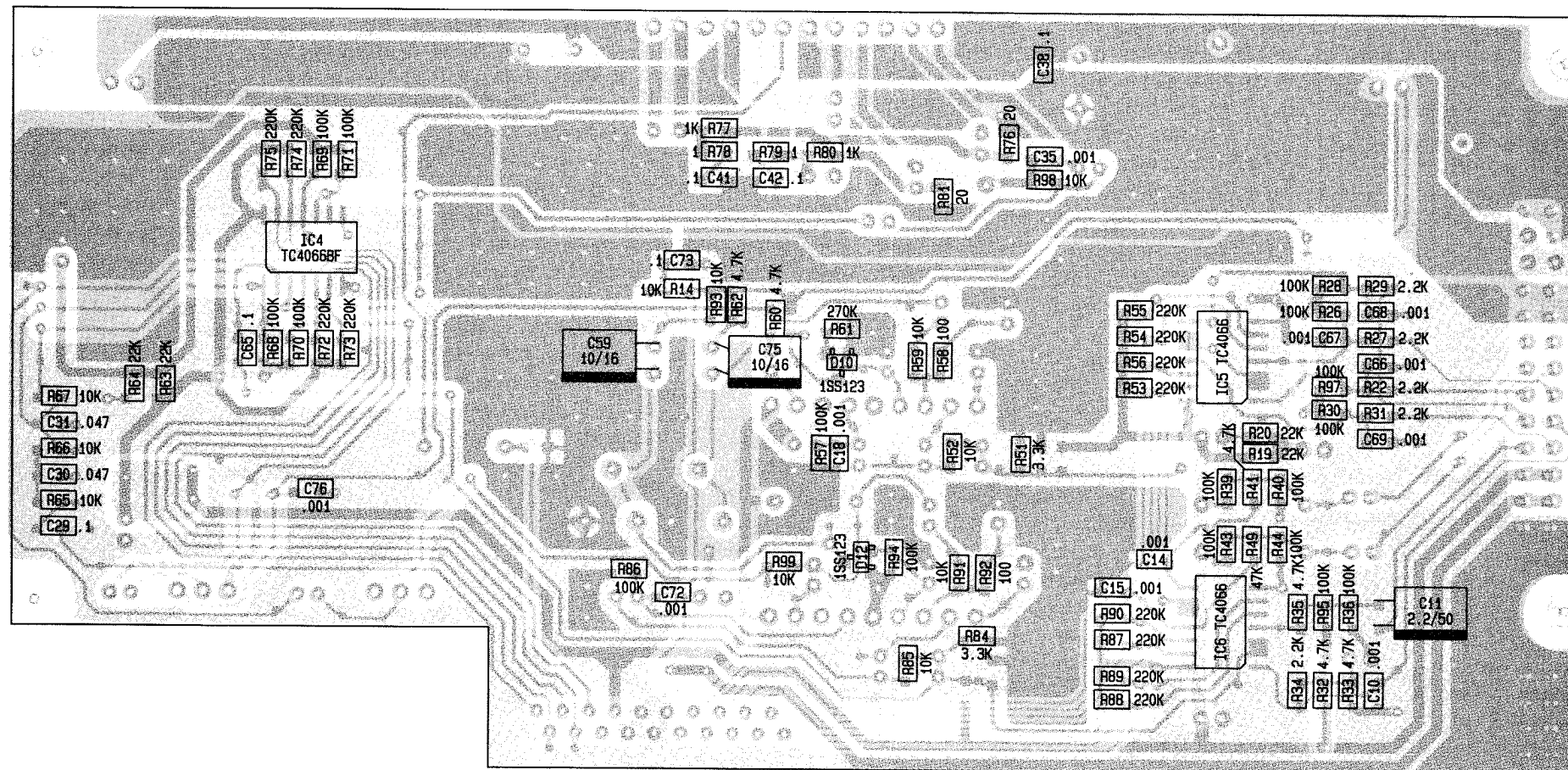

Figure 6-3
Schematic Diagram
(Main Section)

6.6 LINEAR A PCB PARTS LAYOUT



TOP VIEW



BOTTOM VIEW

Figure 6-4
Linear A PCB
Parts Layout

6.7 LINEAR B PCB PARTS LAYOUT

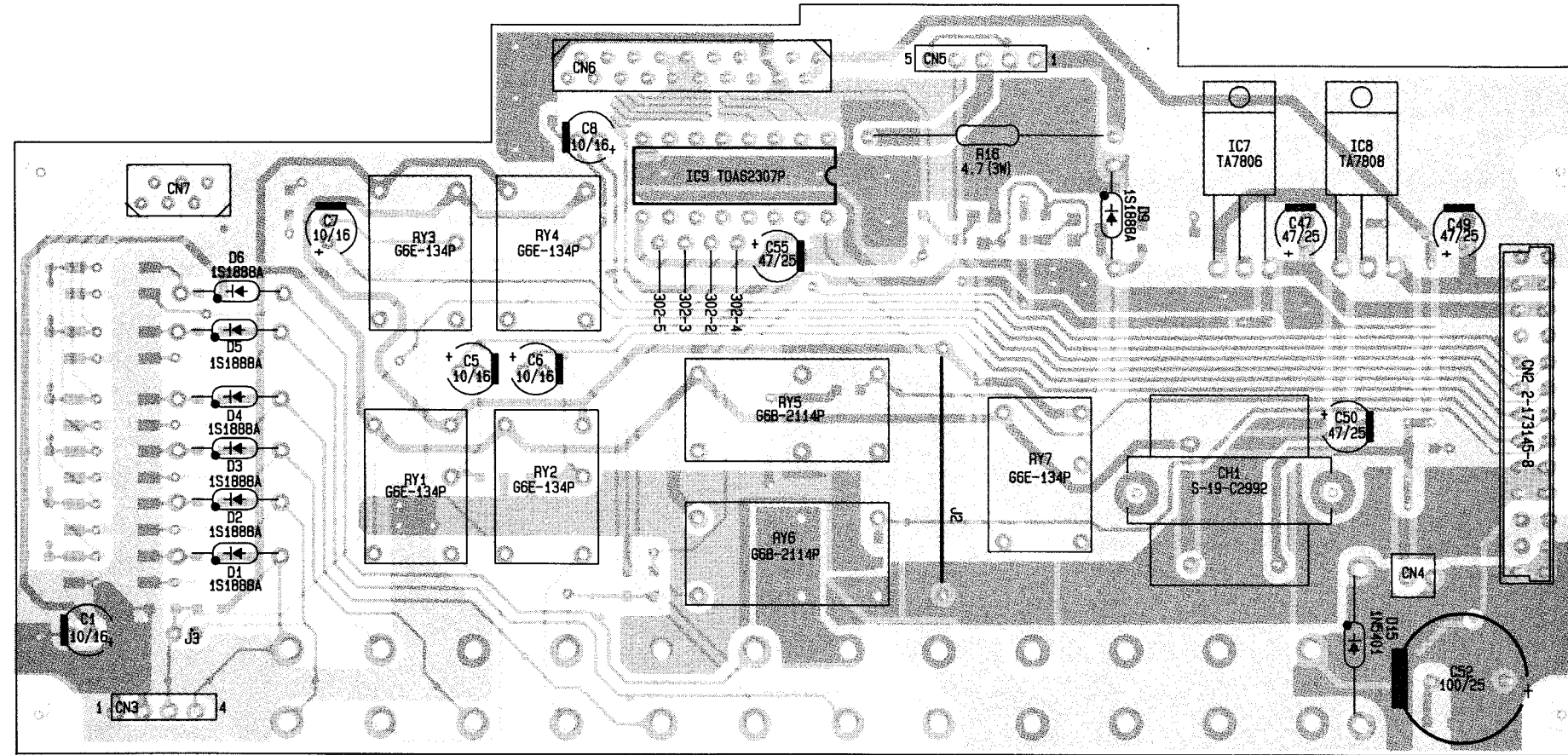

TOP VIEW

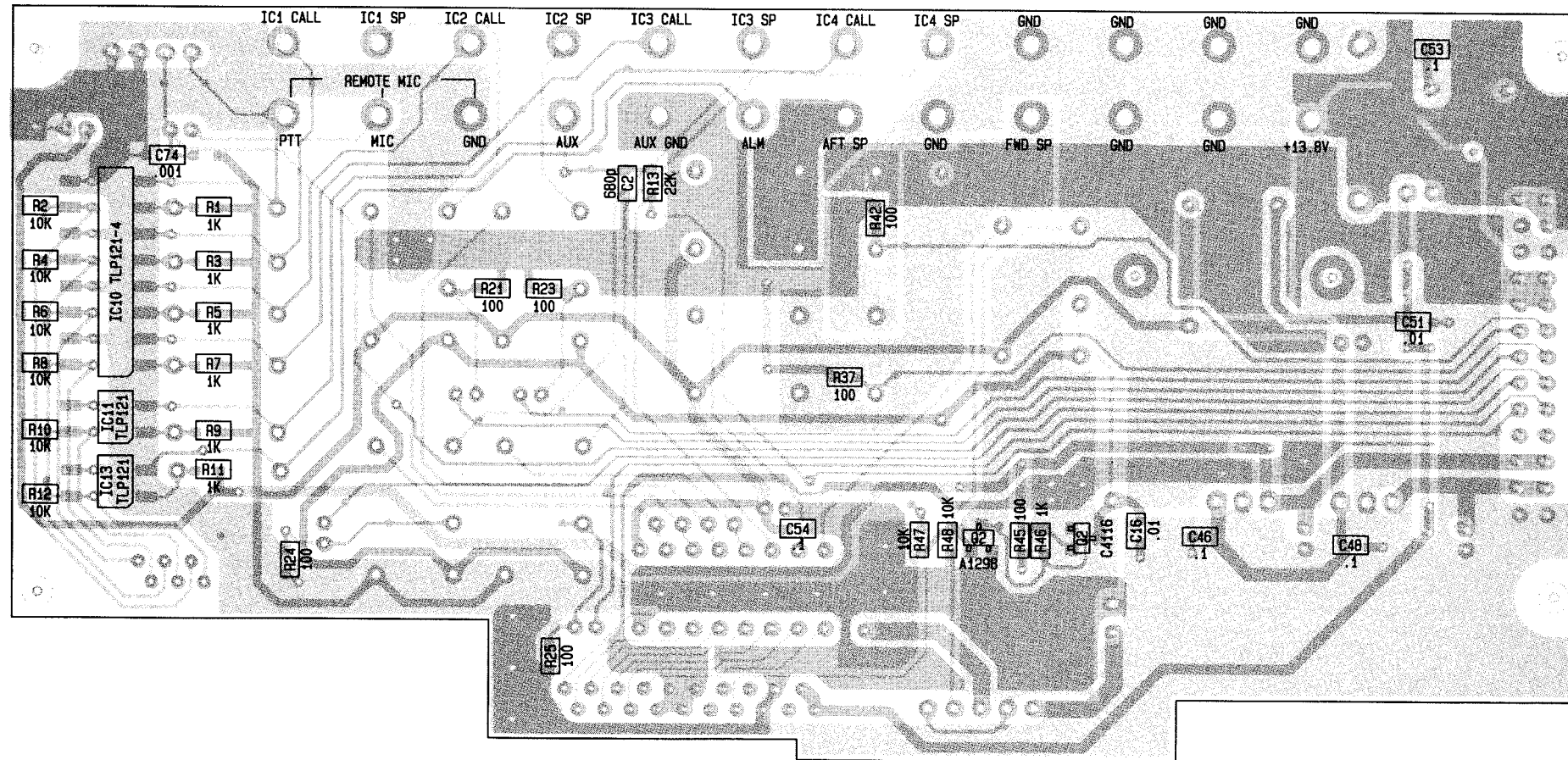

BOTTOM VIEW

Figure 6-5
Linear B PCB
Parts Layout

6.8 CPU PCB SCHEMATIC DIAGRAM

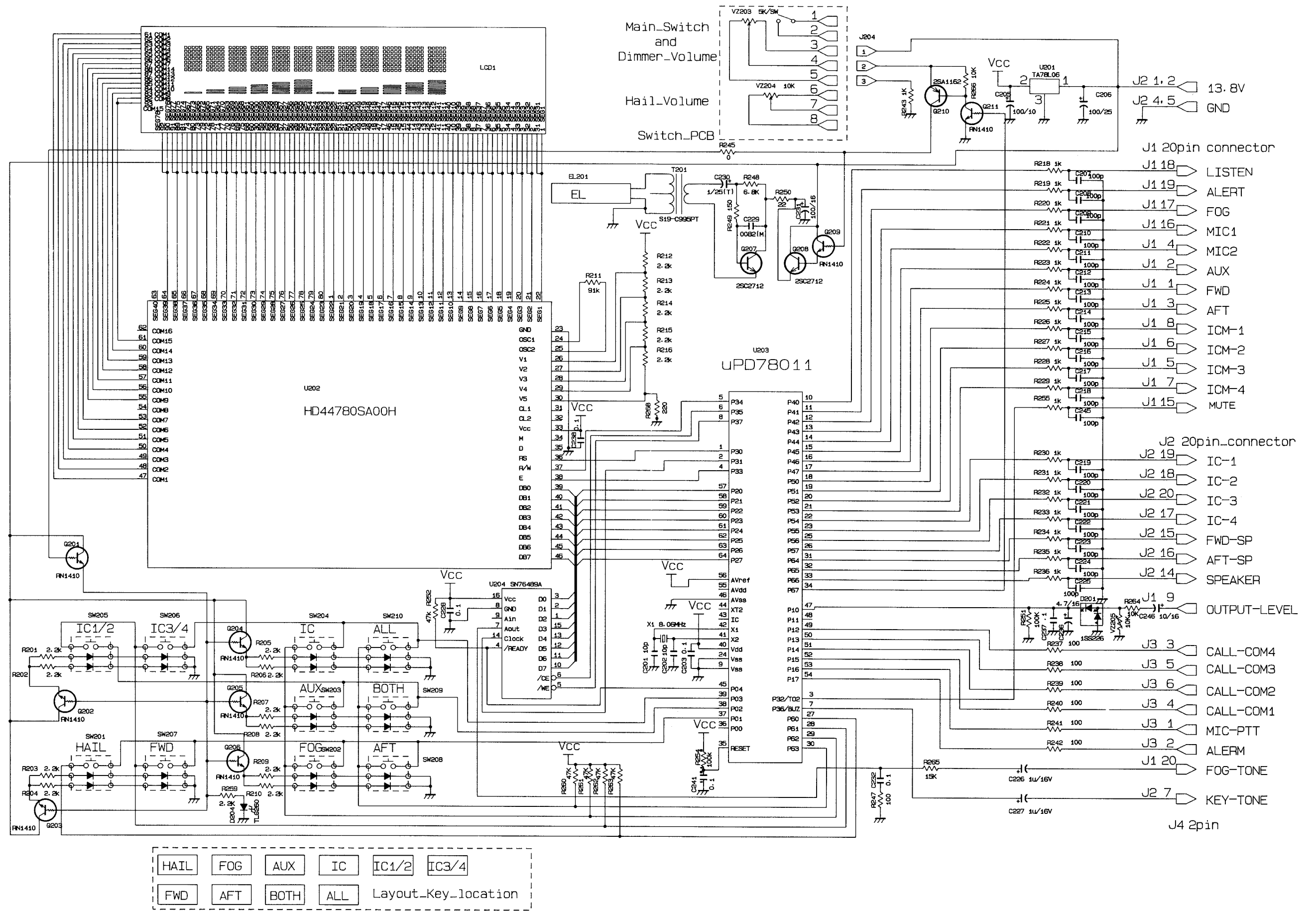
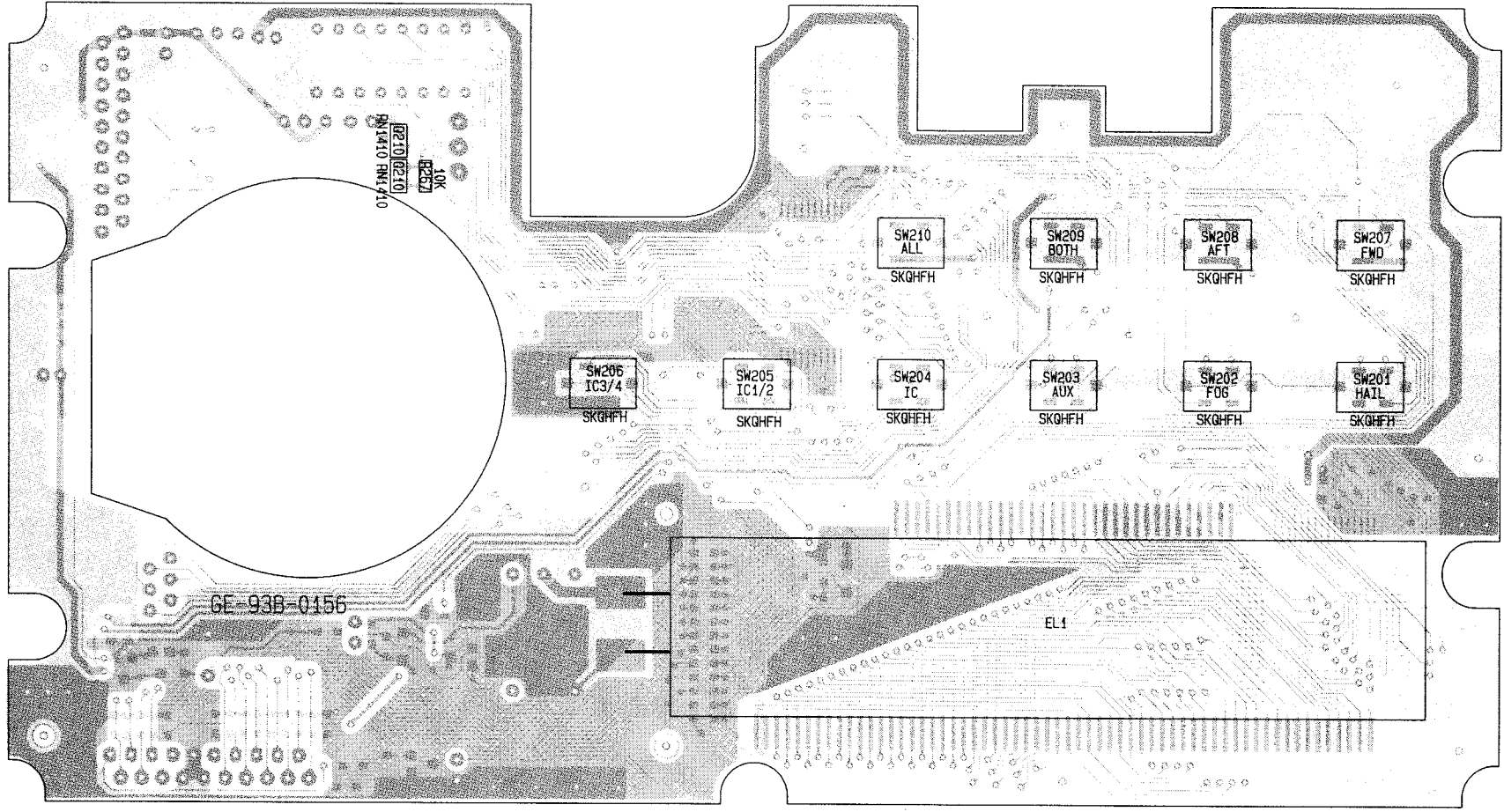
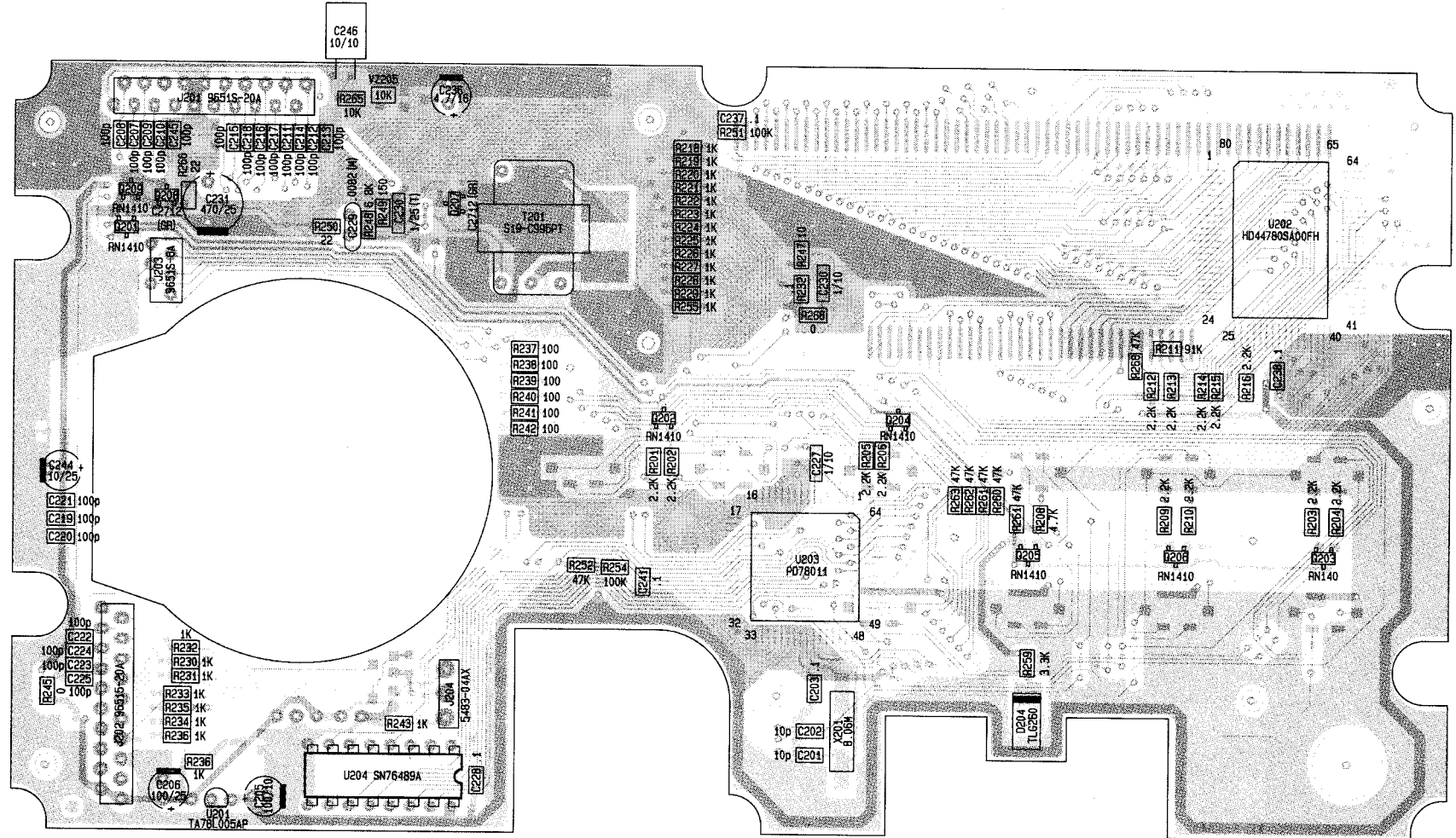

Figure 6-6
Schematic Diagram
(CPU Section)

6.9 CPU PCB PARTS LAYOUT



TOP VIEW



BOTTOM VIEW

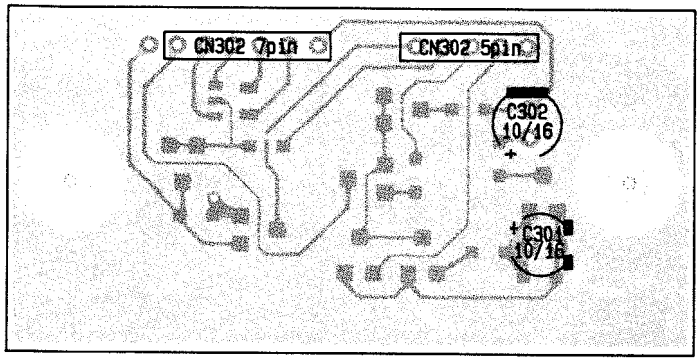

TOP VIEW

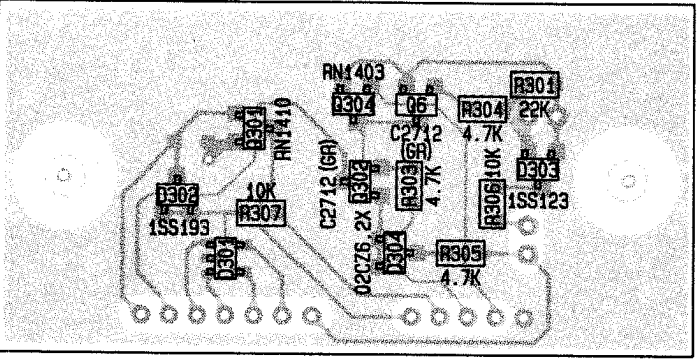

BOTTOM VIEW

Figure 6-8
AGC PCB
Parts Layout

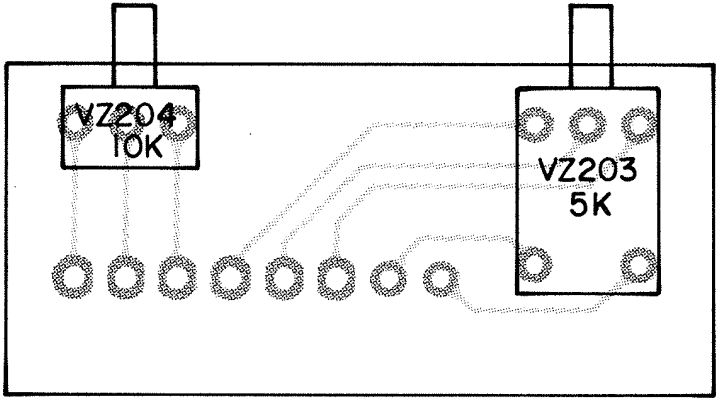

TOP VIEW

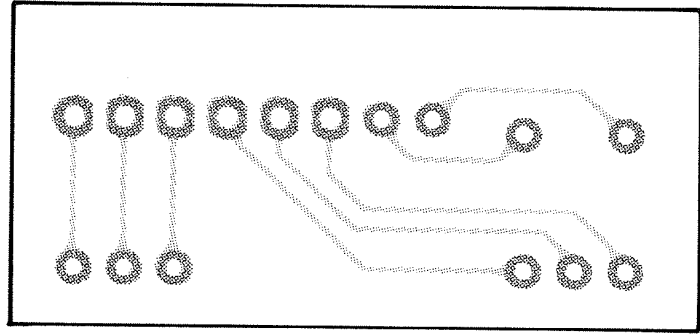

BOTTOM VIEW

Figure 6-9
Volume PCB
Parts Layout

Figure 6-7
CPU PCB
Parts Layout

